

EVOLUTION ELECTRIC STEAMER INSTALLATION & OPERATOR MANUAL

Connected Model



Connection-less Model Double Stack



Drain pans are customer supplied

IMPORTANT WARRANTY INFORMATION

WARRANTY REGISTRATION - STARTUP FORM INSIDE THIS MANUAL MUST BE REMOVED, COMPLETED, SIGNED BY CUSTOMER AND A COPY EMAILED, FAXED OR MAILED BACK TO ACTIVATE THE LIMITED WARRANTY.

These installation instructions have been prepared for qualified electric equipment installation personnel, who should perform the installation, initial field start-up and complete the equipment adjustments described in this manual.

TABLE OF CONTENTS

SAFETY WARNINGS INFORMATION	PAGE 2
START UP FORM	PAGE 3
GENERAL INFORMATION	PAGE 5
INSTALLATION	PAGE 7
OPERATION - USE	PAGE 14
OPERATION - CLEANING	PAGE 18
TROUBLESHOOTING	PAGE 21
SERVICE	PAGE 22
PREVENTATIVE MAINTENANCE CHECKLIST	PAGE 23
WARRANTY	PAGE 24

DOCUMENT HISTORY

CURRENT REVISION	DATE	PRIOR REVISION	DATE	CHANGE
1903	04/03/2019	1003	04/14/2010	Review and update of manual

IMPORTANT FOR YOUR SAFETY

The safety instructions listed below on this page should be posted in a prominent location as a reminder of safe practices as well as recommended actions to follow in the event of an equipment or facility utility issue.

WARNING

In the event of a power failure, do not attempt to operate this appliance.

WARNING

Improper installation, adjustment, alteration, service or maintenance can cause property damage, injury or death. Read the installation, operating, and maintenance instructions thoroughly before installing or servicing this equipment.

WARNING

Only qualified service technicians/electricians should install this appliance to ensure that all electrical and safety requirements are met and that all wiring is installed in accordance with all national, state and local electrical codes.

SERIAL NUMBER:	MODEL NUMBER:
----------------	---------------

Location Name:	Date:	
Street Address:	Service Company:	
	Street Address:	
State/ Zip Code:	State/ Zip Code:	
Building Name/#:	Service Phone #:	
Contact Name:	Technicians Name:	
Phone:	Technicians Email:	
Email:	Additional Info:	

- AccuTemp Products, Inc. is not responsible for the installation, nor does it recommend modifications to the electrical supply sources, Any in-field modifications made without written authorization from AccuTemp Products, Inc. will void all written and oral warranties.
- It is recommended that the wall receptacle be placed as low as State and Local codes allow. Placement in high heat zones will cause service issues that will not be covered under the product warranty.

THIS START-UP FORM MUST BE COMPLETELY FILLED OUT, EMAILED, FAXED OR MAILED OR EMAILED TO THE ACCUTEMP TECHNICAL & CUSTOMER SUPPORT DEPARTMENT, BEFORE THE WARRANTY IS ACTIVATED.

	YES	NO
1. Is the steamer being installed at an altitude greater than 2,000 feet (Tick Box)		
2. Is the steamer level? (Tick Box)		
3. Is the wall receptacle positioned in a low heat zone? Note: It is recommended that the wall receptacle be placed as low as State & Local codes allow. Placement in high heat-zones like: just above, below, or beside the exhaust flue; will cause service issues that will not be covered under the product warranty. (Tick Box)		
4. If the steamer has legs, have the (4) rubber foot tips been installed (Tick Box)		
5. Is the supply cord plugged into a wall outlet? (Tick Box)		
6. Is the supply cord being hardwired, without the plug, to a breaker box (if YES, be aware this voids the UL listing and may affect warranty. Tick Box)		
7. Is the supply cord properly connected to GND (Tick Box)		
8. What is the Electrical Breaker Amperage that will interrupt the Supply Voltage to the Unit:	____AMPS	

Confirm Supply Power Electrical Readings

Phase: Single ϕ Three ϕ

Supply Voltage:

208VAC 240VAC 440VAC 480VAC

Amperage Draw on each leg:

Single ϕ ____WHT ____BLK

Three ϕ ____WHT ____BLK ____RED

EVOLUTION Steamer Start-Up Form (continued)

YES NO

9. Is the correct NEMA Plug and Receptacle being used on the supply power cord?(Tick Box)			
Type of NEMA Plug	Tick One		Tick One
L6-30P (208/240V 6kW)		L16-20P (480V 14kW)	
L15-30P (208/240V 10kW)		IEC 60309-2 (230/415V)	
15-50P (208/240V 15kW)			

Connected (Auto-fill) Models Only

YES NO

10. Is the supply water pressure lower than 30PSI (Tick Box)		
11. With the Steam Collector Pan removed and the Steam Chamber empty, does the Auto-Fill Water Stream hit the chamber floor half-way to three-quarters of the way towards the opposite wall? Note: The Auto-Fill Valve has a maximum water supply pressure of 60 psi. If stream goes beyond ¾ or IF water pressure gauge is > 60 psi, THEN install water regulator.		
12. Is the chamber water level at (or just below) the stamped water line on inside left chamber wall after auto fill has been completed? (Tick Box)		
13. Is the Float Ball Installed in the unit? (Tick Box)		
14. Is there a High Water alarm when the Float Ball is removed? (Tick Box)		

All Models (Connected & Connection-less)

YES NO

15. Does the Low Water Light and Alarm turn OFF once the chamber water level has reached the middle of the Low Water Sensor? (Connected Water Models will only have the Low Water Light and no Alarm. Tick Box.)		
16. Has additional piping been added to the steam vent? (Tick Box) Reference Page 12 for guidance.		
17. Verify the water temperature in COOK MODE (COO on digital display) _____ °F		
18. Does the unit cycle the heat once it is in COOK MODE? (Tick Box)		
19. Is there any added drain hose/piping attached to the Steamer Drain System? Note: Does the added drain hose/piping to the steamer meet the specifications listed on the instruction label attached to the back of the steamer? (Tick Box)		
20. If unit is part of a double stack, does the top steamer have a drain kit installed? (If NO, Warranty is void until kit is installed. Tick Box).		
21. Take photographs of install, including: Front of steamer, Side view of steamer, hook up and supply. (Tick Box)		

I accept this Start-up form as complete and accurate:

Signed: _____ Restaurant Management Date: ____/____/____

Print Name: _____

ACCUTEMP PRODUCTS INC.
4815 N CLINTON PARK DR - FORT WAYNE - IN - 46825
TELEPHONE: 800-480-0415, SERVICE@ACCUTEMP.NET
PRINTED IN USA

1. GENERAL INFORMATION

AccuTemp appreciates your decision to purchase our equipment. Your new equipment combines the long-term experience of the best chefs together with the latest scientific and modern technologies. With the help of your new equipment, you shall always achieve the highest quality dishes and a superior product. To ensure that you succeed right from the beginning in gaining the best results, we would like to provide you, through this manual, with all the information necessary for smooth operation.

AccuTemp guarantees proper functioning and high-quality service.

We offer:

- 12-month guarantee of flawless operation of the equipment.
- Warranty service and post-warranty support.
- Technical and advisory services in connection with servicing and maintenance.
- Chef expert advisory service.

We hope that you enjoy working with AccuTemp equipment and that you always have many satisfied guests.

This manual contains available information on the AccuTemp equipment accessible at the time of publication of this manual. Errors and technical modifications are under the usual provision.

1.1 Contact

Should you have any questions we are at your service at the following telephone numbers and addresses.

AccuTemp Products
8415 N Clinton Park Dr
Fort Wayne, IN 46825

Tel: 800 480-0415
Fax: 260 469-3045
E-Mail: service@accutemp.net

1.2 Use of the operating instructions

Read carefully and follow the instructions for operation and maintenance of your equipment. Should some of the procedures be unclear, contact your salesperson for further assistance.

SYMBOLS USED

The symbols used here draw attention to activities that may influence safety, health protection and the necessity for servicing. They help you to prevent problems and the advice will make your work easier.



WARNING

Indicates a potentially hazardous situation; which, if unchanged, will result in death or serious injury.



CAUTION

Indicates a potentially hazardous situation; which, if unchanged, will result in minor or moderate injury



NOTE

Advises reader of information or instructions vital to the operation or maintenance of the equipment



EARTH GROUND



DANGEROUS VOLTAGE



HOT SURFACE

1.3 Warranty Restrictions

All the technical information, data, operation and maintenance instructions contained in this operating manual correspond to the final state upon delivery and were compiled with regard to our previous experience and to our best knowledge. We reserve the right to carry out technical changes on the equipment described in this operating manual as part of further development of the equipment.

We do not accept any responsibility for any damage or failures arising from incorrect operation, lack of attention to this manual, use of aggressive chemical cleaning products and technically incorrect repairs. We call your attention to the fact that this also applies to spare parts not delivered by us and to accessory equipment not pre-tested and approved by us.

All modifications or changes made to the equipment through your own efforts are not permitted for the reasons of safety and relieves AccuTemp of any responsibility for damage arising there from. Within the scope of the warranty obligations negotiated in the contract under the exclusion of further claims, we accept responsibility for accidental mistakes or neglects.

Claims for reimbursement for damages are not possible regardless of upon what judicial reason such claim is made.

2. EQUIPMENT DATA PLATE

2.1 Labeling

Model: **A B CCC D E FFF G H I J K**

Where:

A is the base model E = Electric

B is the size of the unit: 6 pan

CCC is the supply Voltage

D is the number of phases: 1 or 3

E is the control series D=Manual Fill, E=Autofill

F is the energy input

G is the timer configuration

H is the thermostat configuration

I is the door configuration

J is the leg configuration

K is the HDW configuration

MODEL	
VOLTS	
AMPS	
HERTZ	
PHASE	
kW	
SERIAL NO	
MFG DATE	

ACCUTEMP PRODUCTS, INC.
FORT WAYNE, INDIANA USA
US PATENT NO. 5,235,903

WARNING: TO PREVENT ELECTRICAL SHOCK, DO NOT OPEN COVER. NO USER SERVICEABLE PARTS INSIDE. REFER SERVICING TO QUALIFIED SERVICE PERSONNEL. DISCONNECT INCOMING AC POWER BEFORE SERVICING.

DO NOT CONNECT TO A CIRCUIT OPERATING AT MORE THAN 150V TO GROUND.

FOR USE ON INDIVIDUAL BRANCH CIRCUIT ONLY.

 **COMMERCIAL COOKING APPLIANCE** 
85Y9
E151437

AT1L-3116-1

3 INSTALLATION

3.1 Installation Notice

Only qualified service technicians/electricians should perform the installation to ensure that all electrical safety requirements are met and that all wiring and plumbing installations are performed in accordance with all national, state and local codes. The installation must conform with local codes.

3.2 Unpacking

This appliance was carefully inspected before shipment from the factory. The transportation company assumes full responsibility for safe delivery to the customer until customer acceptance of the package. Careful inspection of the packaging and the appliance should be completed before acceptance from the transportation company.

3.3 Steamer Lifting

Steamers are heavy enough to require additional manpower or powered assistance when installing or moving the steamer.

 When moving the equipment manually make sure there are enough people for the task as the equipment is heavy.

 Make sure the equipment is not dropped during moving. People doing the carrying could be seriously injured and/or the equipment damaged. The manufacturer does not accept any responsibility for damage resulted from such actions.

3.4 Location and Placement

The AccuTemp Evolution steamer can be placed on a commercial kitchen counter-top, flush mounted or installed on an AccuTemp Evolution steamer stand. Provisions should be incorporated in the kitchen to ensure an adequate supply of fresh air for proper combustion and ventilation (FIGURE 1).

The steamer must be installed in a level condition. An out of level condition may cause erratic operation and damage to the steamer. Damage of this kind is not covered by the limited warranty. Use a spirit level resting on the top surface of the steamer to ensure it is level front to back and left to right.

 For the correct operation of the steamer it is important that it is leveled in a horizontal position.

 Placement on an unlevel or uneven surface may result in performance faults. Only professional installation of the device guarantees it high-quality operation.

 Check proper setting of the equipment by placing a hotel pan filled with water inside the steamer and observing the water level.

 A minimum clearance of 10 inches must be allowed for on the left hand side of the unit for maintenance access to the unit. Failure to provide this may limit the effectiveness of service dispatch and incur additional costs not covered by warranty.

FIGURE 1: EQUIPMENT CLEARANCE INFORMATION

FOR COMBUSTIBLE & NONCOMBUSTIBLE BUILDING MATERIALS

LOCATION	COMBUSTIBLE	NONCOMBUSTIBLE
SIDES	1"	0"
REAR	2"	0"

FOR OTHER SOURCES OF HEAT: FRYERS, OPEN RANGE, STEAM VENTS. For open flame, this is the minimum distance from the flames while they are in operation.

LOCATION	
LEFT	3"
RIGHT	3"
REAR	3"

Counter Top Placement

In a counter top installation the steamer can be leveled using the adjustable legs. Once this is complete it is required that the supplied (4) rubber foot tips be installed to keep the steamer from possibly sliding on the counter top under normal use.

3.5 Stand Installation

If an AccuTemp Evolution Steamer Stand is used ensure the floor is level and place the two locking casters to the "ON" position.

 When using a stand that is equipped with casters, the floor surface must be level and flat. Failure to do so can result in a "tipping" hazard that could result in serious injury.

3.5.1 Single Steamer Stand Installation Instructions

The AccuTemp single stand can be equipped with adjustable height feet or non-adjustable casters (FIGURE 3).

1. Before mounting a steamer on the stand with casters, engage the two front locking casters, pressing on the "ON" handle of the brake mechanism.
2. To mount the steamer, carefully lift and place it on the horizontal mounting brackets ensuring that the (4) mounting holes on the underside of the Evolution are lined up with mounting holes of the brackets.
3. Then, using a 7/16" wrench, fasten one pair of the 1/4" -20 hex bolt and 1/4" split lock washer through the underside of each stand bracket mounting hole into the Evolution and tighten securely.
4. With the SNH-10 stand, level the steamer by adjusting the feet found at the ends of each stand leg, either up or down as needed.

 When installing units on a double stand, always install the lower unit first. Installing the upper unit first could cause the stand to topple.

3.5.2 Double Stand Installation Instructions

The AccuTemp double stand can be equipped with adjustable height feet or can be equipped with non-adjustable casters and accommodates (2) E6 model Evolutions (FIGURE 4).

1. Before mounting a steamer on a stand with casters engage the brakes on the two front locking casters, pressing on the "ON" handle of the brake mechanism.
2. Always mount the first EVOLUTION on the bottom of the stand. To mount the bottom steamer, carefully lift and place it on the horizontal mounting brackets, ensuring that the (4) mounting holes on the underside of the Evolution are lined up with the mounting holes on the brackets.
3. Then, using a 7/16" wrench, fasten one pair of the 1/4"-20 hex bolts and 1/4" split lock washers through the underside of each stand bracket mounting hole into the Evolution and tighten securely.
4. Once the bottom steamer has been installed, carefully lift and place the top Evolution steamer on the horizontal mounting brackets, ensuring that the (4) mounting holes on the underside of the Evolution are lined up with the mounting holes on the brackets.
5. Then, using a 7/16" wrench, fasten one pair of the 1/4"-20 hex bolts and 1/4" split lock washers through the underside of each stand bracket mounting hole and tighten securely.
6. With the SNH-20 stand, level the appliances by adjusting the feet found at the ends of each stand leg, either up or down as needed.

3.5.3 Flush Mount Installation

To Flush mount the appliance to a counter, follow these steps:

1. Drill 4 holes as seen in FIGURE 2.
2. Attach the appliance to counter top with (4) 1/4-20 x 3/4" hex head bolts and 1/4-20 split lock washers.
3. Apply a bead of high temp food grade silicone caulking around the perimeter and smooth out.

FIGURE 3: MANUAL FILL UNIT ON SINGLE STAND



FIGURE 4: MANUAL UNITS ON A DOUBLE STAND

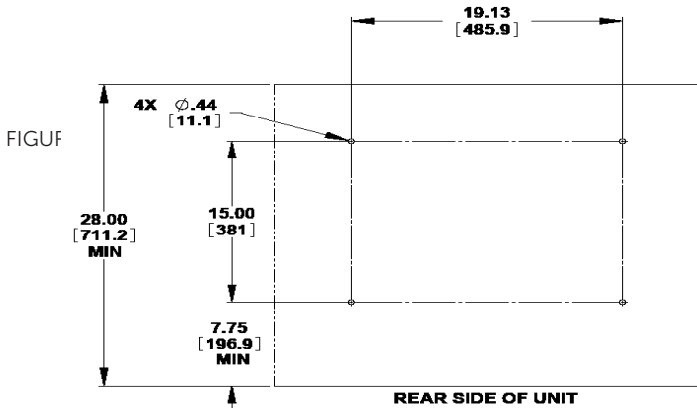

3.6 Steamer Connections

The Evolution Electric Steamer is available in a connected and connection-less models.

Both the connection-less and connected model will require an electrical connection.

CONNECTED UNITS:

The connected model in addition to the electrical connection will require a water connection and access to a floor drain or sink to route a drain hose (not supplied) to allow condensate to be removed and to drain the steamer when required.

See FIGURE 5 for identifications of the required steamer connections.

CONNECTIONLESS UNITS:

This model must be manually filled with tap water and must be filled throughout the cooking process to assure consistent cook times.

 Do not use the "Low Water Indicator" as your indication that this steamer requires water as this actually turns off the heat to the product thus stopping the cooking process.

 A full size steam table pan or a 1/1 gastronome pan must be installed in rails under the steamer any time the steamer is operating and anytime that the steamer is being cleaned or drained of the water in the cooking chamber. Failure to follow this directions will cause a the steamer to fail which is not covered under the limited warranty (FIGURE 6).





FIGURE 6: MANUAL FILL UNIT ON SINGLE STAND









FIGURE 5 - TEXT ENCIRCLED BOLD ARE SHARED CONNECTIONS BETWEEN BOTH MANUAL AND AUTO-FILL UNITS



3.7 Electrical Requirements and Notices

-  The electrical voltage requirement is listed on the data plate that is located on the lower left side panel.
-   All AccuTemp Evolution Electric Steamers are supplied with a power cord and plug that must be connected to the specified receptacle, see below for reference.
-  Make sure the voltage is within 10% of the voltage listed on the steamer data plate.
-  Connection to any other voltage not identified on the data plate will cause damage to the components and is not covered under warranty.

Grounding provides a path for electric current to reduce risk of shock.

-  This product is equipped with a power cord having a grounding plug. If plug is removed or hard wired, UL approval is lost.
-  The plug must be plugged into a receptacle that is properly installed and grounded in accordance with all National, State and local electrical codes or in the absence of local electrical codes with the National Electric Code, ANSI/NFPA 70, or the Canadian Code, CSA C22.2 as applicable.
-  Under no circumstances shall the plugs grounding prong be cut or bent to fit a receptacle other than the one specified.
-  Do not use any adapters.
-   Any in-field modification made that bypass the safety features of this appliance will result in serious injury or death. DO NOT DIRECT WIRE THIS APPLIANCE.
-  Any in-field modifications made without written authorization from AccuTemp Products, Inc. will void all written and oral warranties.

ELECTRICAL SPECIFICATIONS CONNECTED

Model #	E62081E060	E62083E100	E62083E150	E62301E070	E62401E060	E62403E110		E62403E130	E64155E110			E64803E140	
Volts AC	208	208	208	230	240	208	240	240	380	400	415	440	480
Phase	1	3	3	1	1	3		3	5			3	
Amps	29	28	42	32	25	22	26	32	14	14	15	16	17
Breaker Size	30 amp	30 amp	50 amp	50 amp	30 amp	30 amp		50 amp	20 amp			20 amp	
Watts (kW)	6	10	15	7	6	8	11	13	9	10	11	12	14
NEMA Plug	L6-30P	L15-30P	15-50P	IEC 60309-2 220/250V	L6-30P	L15-30P		15-50P	IEC 60309-2 220/380-240/415V			L16-20P	

CONNECTIONLESS

Steamer Model "D" Specifications													
Model #	E62081D060	E62083D100	E62083D150	E62401D060	E62403D110		E62403D130	E62301D070	E64155D110			E64803D140	
Volts AC	208	208	208	240	208	240	240	230	380	400	415	440	480
Phase	1	3	3	1	3		3	1	5			3	
Amps	29	28	42	25	22	26	32	32	14	14	15	16	17
Breaker Size	30 amp	30 amp	50 amp	30 amp	30 amp		50 amp	50 amp	20 amp			20 amp	
Watts (kW)	6	10	15	6	8	11	13	7	9	10	11	12	14
NEMA Plug	L6-30P	L15-30P	15-50P	L6-30P	L15-30P		15-50P	IEC 60309-2 220/250V	IEC 60309-2 220/380-240/415V			L16-20P	

3.9 Connected Model - Additional Connections

3.9.1 Supply Water Line (FIGURE 11)

 The installation of the water connection to the appliance is the responsibility of the owner and or installer.

 An inlet strainer in water inlet must be used, removal of strainer voids steamer warranty.

 The installation of this appliance should comply with all applicable federal, state or local plumbing codes.

 The installation requires a check valve (or other approved anti-back flow/ anti-siphon device) in all supply lines in accordance with and as required by local, state and national health, sanitation and plumbing codes. AccuTemp does NOT provide a check valve with the steamer.

- Design the water supply line so the unit can be moved for service. Install a manual water shutoff valve between the water supply line and the steamer supply line.
- A reinforced rubber or braided stainless steel appliance hose rated for the temperature and pressure of the water supply with a 3/4" garden hose type connection is required.
- The Garden Hose Thread (GHT) connector used must be suitable for potable water
- Do not apply pipe thread sealant to GHT connections.
- Either hot or cold water can be connected to the steamer. If hot is used, temperature must be less than 180°F.
- The hose must not be sharply bent, kinked or twisted.
- If the steamer is close to a wall, use a right angle fitting to prevent kinking the hose
- The Auto-Fill Valve has a maximum water supply pressure of 60 psi. If stream goes beyond 3/4 or IF water pressure gauge is > 60 psi, THEN install water regulator.
- Flush the water supply lines before connecting the lines to the appliance.
- Connect the water supply lines to the steamer.

3.9.2 Drain Line Connection

Floor Drain

 The steamer should be located close to, but not within 20" or directly over, a floor drain.

- Connect a 3/4" ID reinforced rubber hose rated for 212°F or higher to the drain fitting on rear of the steamer with a hose clamp (Connected Units ONLY).
- Run the hose to the drain. DO NOT directly plumb the steamer to the drain, Leave a one-inch air gap between the hose and the drain.
- The hose must drop 1/4" (inch) per foot to the drain.
- Ensure no loops form in the drain line as this can cause a backup and will affect the operation of the unit

 The unit should not be located within 20" of a floor drain.

Optional Drain Connection

Run the hose to a funnel fitting leaving a one-inch gap between the hose and the top of the funnel. The drain hose must slope toward the floor drain or funnel.

FIGURE 10
CONNECTED UNIT





FIGURE 11
CONNECTION-LESS

STEAM EXHAUST VENT
DO NOT CONNECT TO GAS,
DRAIN OR WATER INLET



3.10 Ventilation

 DO NOT connect Drain or Vent lines on multiple appliances. Each appliance should have its own dedicated drain and vent.

 The steam vent is provided with a 45 ° elbow. The steam vent must not be obstructed. An obstruction will prevent correct operation of the steamer.

 Applicable federal, state and/or local plumbing codes will dictate when and if a hood is required.

3.10.1 Steam Vent Extension

When adding anything to the vent on the Evolution steamer, care must be taken to prevent doing anything that puts a back pressure on the steamer. Back pressure on the steamer may interfere with the pressure switch that controls the heaters. When the pressure switch senses pressure in the steamer that is 0.5" of water column or more, it turns the heaters off. Therefore, anything on the vent putting a pressure of just 0.5" water column on the steamer turns the heaters off and prevents them from coming on again until the pressure is relieved. Intermittent operation of the steamer can often be traced to restrictions, low spots or a plugged condensate drain in the vent fitting assembly.

To prevent putting a back pressure on the steamer, vent piping should have no restrictions and no low spots where water can accumulate. Ventilation piping can be directed upwards toward hoods or downward towards floor drains. Slightly different approaches are required for each application.

Extension Sloping Upward (FIGURE 12)

1. Use nominal 3/4" copper, brass or stainless steel to prevent flow restrictions. Larger inside diameter (ID) can be used also
2. Pipe should slope upward a 1/4" per foot from the steamer vent toward a vent hood to allow water condensing in it to run back to the steamer and down the drain line. Minimum recommended slope is 1/4" per foot of hose length.
3. Use rigid pipe rather than flexible tubing or hose to prevent dips or sags in the pipe that may collect water. A puddle of water in the piping just 1/2" deep will cause the steamer to malfunction. Recommended pipe materials are rigid 3/4" copper tubing (7/8" OD) or brass/ 18-8 stainless steel pipe (3/4 NPT or larger). Pipe hangers or pipe supports should be used every six feet to prevent long runs from sagging.
4. A pipe union should be installed next to the steamer to permit the vent to be easily disconnected. This allows the steamer to be easily moved for servicing.
5. Total length of extended vent piping should not exceed 15 feet.

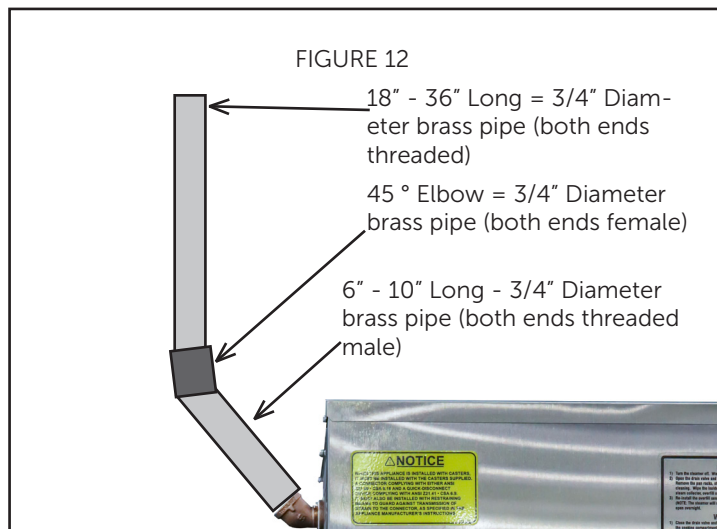

Extension Sloping Downwards (FIGURE 13)

1. Use nominal 3/4" or larger inside diameter (ID) to prevent flow restrictions.
2. Pipe should slope downwards from the steamer vent to a floor drain to allow water condensing in it to run unimpeded into the floor drain.
3. For downward sloping extension to a floor drain ONLY – 3/4" ID or larger reinforced silicone hose (auto radiator hose) may be used. The hose end must be open and not submerged. Avoid any low spots that will cause puddles of water and increase of back pressure.
4. Total length of extended vent piping should not exceed 15 feet.

Mounting vent Extensions On Two Steamers on a Double Stack Stand.

 DO NOT connect Drain or Vent lines on multiple appliances. Each appliance should have its own dedicated drain and vent.

Each steamer's vent must be extended individually. Tying multiple vents together will result in the steamers being unable to regulate heat.

For the both steamers, follow the instructions as provided above in **Extension Sloping Upward.**

The lower steamer's vent must exit above the top of the upper steamer (FIGURE 14).

When designing the extension to slope downwards, whether using rigid or flexible hosing, pipe hangers or pipe supports should be used every six feet to prevent long runs from sagging. The end of the hose/pipe should not be submerged to prevent steam backups (FIGURE 15).

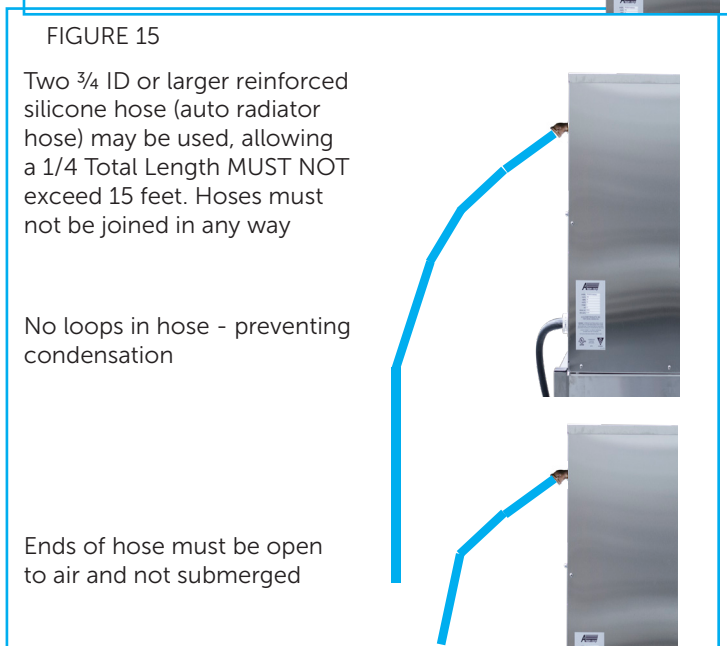
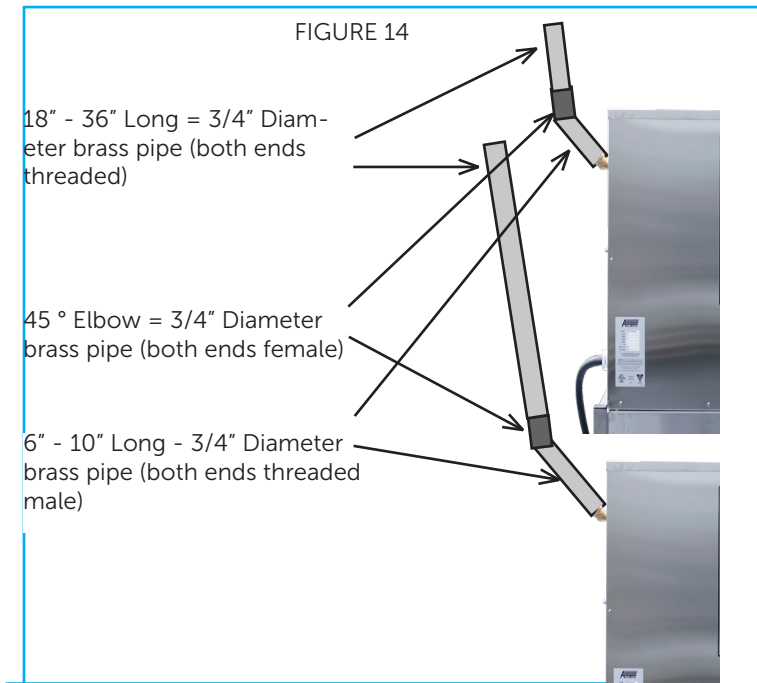
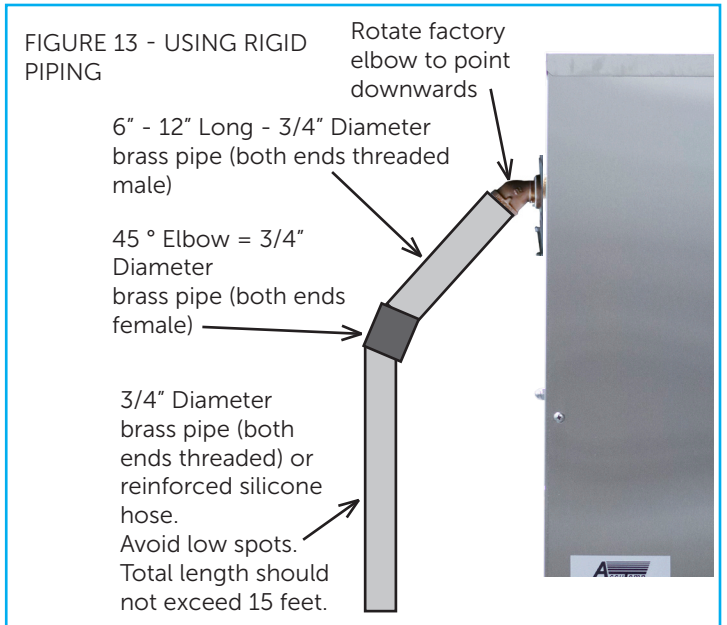

4. OPERATION

⚠ RISKS RESULTING FROM CONTACT WITH VERY HOT OBJECT:

☄ STEAM

When opening the door, particularly during steamer operation, always stand in such a way that the hot steam escaping from the partially open door cannot scald you. Open the door only partially and open fully only once the steam has escaped.

☄ HOT

Hot areas may form during the cooking process, especially on the cookware, grills and the inner side of the door. Use protective gloves whenever handling hot objects. During the cooking process, do not handle cookware containing liquids or liquid foodstuffs located above eye level. Danger of burns.

⚠ Be sure all operators read, understand and follow the information contained in this manual including caution warnings, operating instructions and safety instructions.

⚠ When accessing the cooking chamber, be sure to always stand back while slowly opening the door to allow the chamber to vent off the steam. Never reach into the cooking chamber before it has completely vented off the steam.

⚠ Never use wet or damp gloves as moisture can conduct heat quickly.

⚠ Keep the floor in front of the equipment clean and dry. If spills occur, clean immediately to avoid potential injuries.

⚠ Do not manually fill water above the water level mark on the left side of the cooking chamber.

⚠ Do not use abrasive (or steel) materials, such as wire brushes, metal scouring pads to clean the cooking chamber bottom.

4.1 Operation Introduction

The AccuTemp Evolution steamer uses the time proven method of cooking with steam. Once the cooking time expires, the steamer can be set to the "Hold Mode". In this mode, the controller regulates the internal temperature. At this time, steam is no longer generated and the cooking chamber is held at the preset temperature at a relative humidity of 100%. This eliminates food from drying out by suppressing the evaporation of the products natural moisture. As a result, most food products can be held in a ready-to-serve state for several hours after cooking, with no appreciable loss in taste, appearance or consistency.

4.2 Sequence of Operation

- When power button is depressed digital display will power on and display "PrE."
- On connected models, low water light will illuminate and unit will begin to fill. On connectionless models, low water light will illuminate and alarm will sound until water is added to the cooking chamber up to the water fill level.
- When the unit has finished filling, low water light will extinguish and alarm will stop. Unit will begin to heat, do not open door as this will slow preheat process.
- Pressing the temperature button will allow users to see current temperature.
- Unit will display "Coo" on display when cooking temperature (approx 212F) has been achieved. The unit will maintain this temperature until powered off or user switches to Hold mode. Product can now be added.

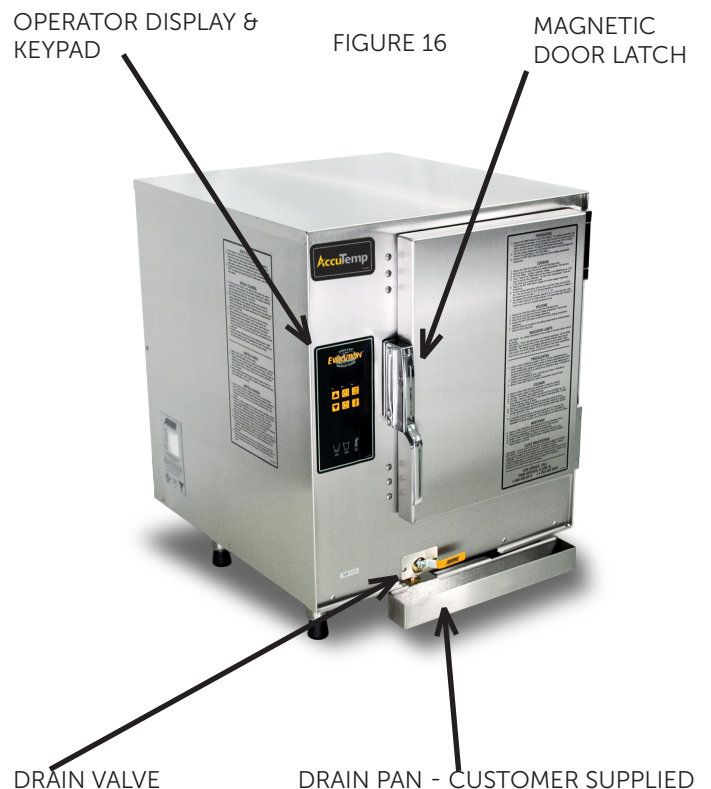
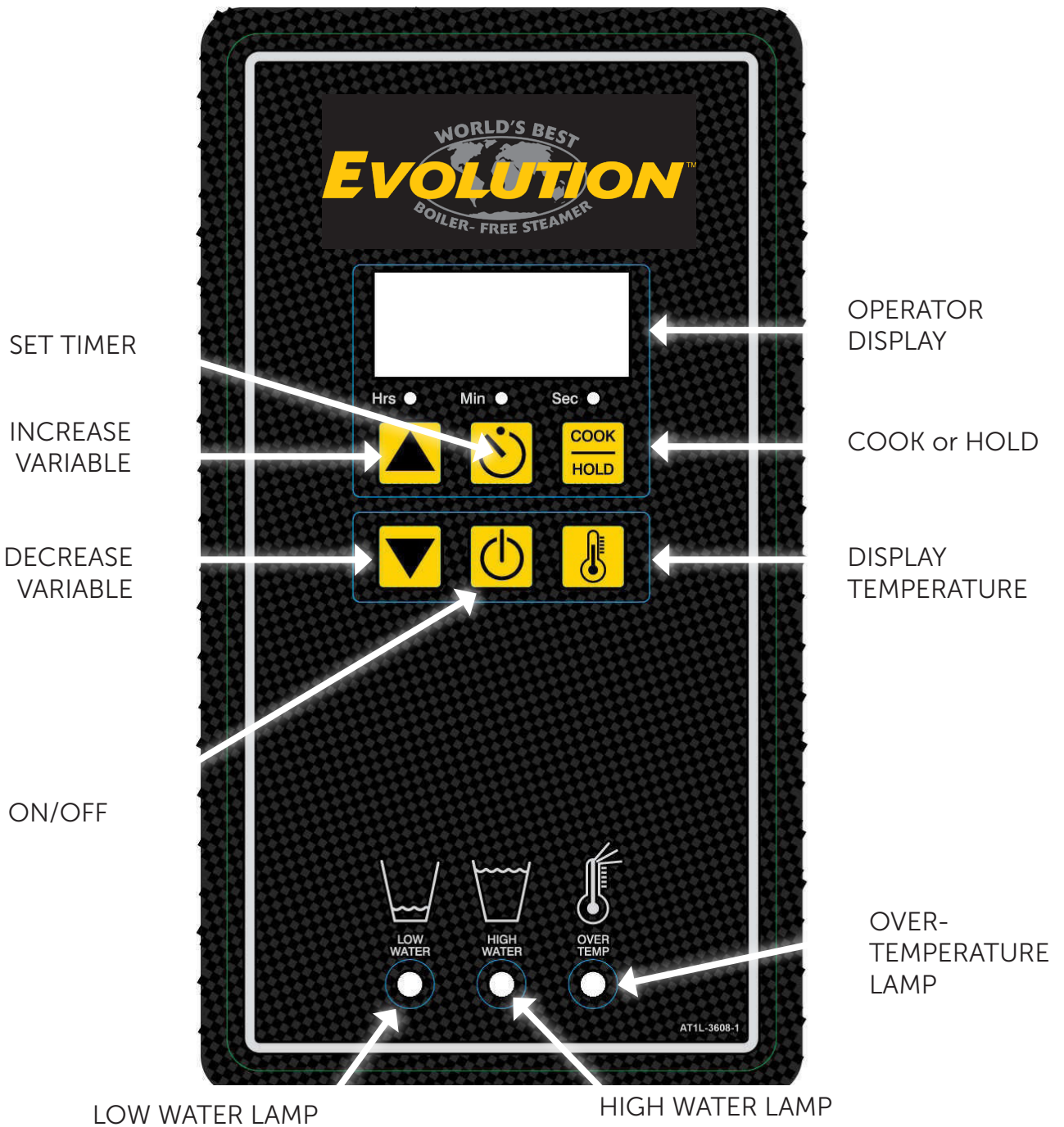

FIGURE 17



4.3 Partial Loads

The Evolution is designed to cook quickly with exceptional pan-to-pan uniformity on full loads of food. Excellent pan-to-pan uniformity can be achieved with partial loads if the pans are optimally placed in the steamer.

For partial loads using 2½" deep pans, the top position in the steamer is used first followed by the second pan placed in third pan position from the top and then the third pan in the fifth pan position from the top (FIGURE 18). Placing the pans in these positions will optimize the cooking time and pan-to-pan uniformity.

FIGURE 18

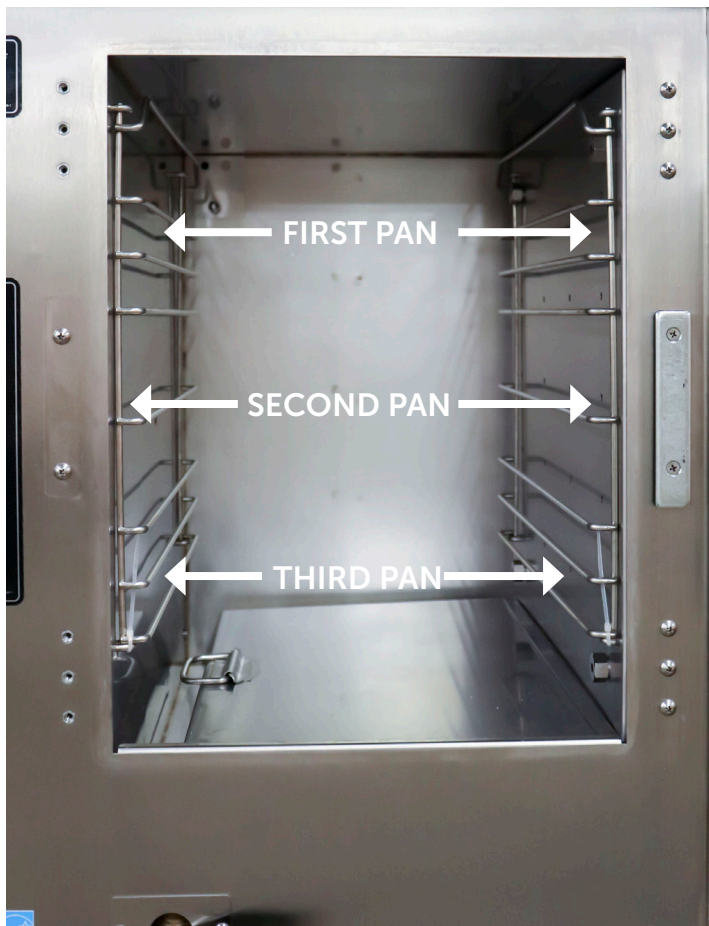

4.4 Daily Preparation for Use - Connected

Preparing the Evolution Connected model for use each day requires very little time and effort. Simply verify that the steamer is clean, the water line to the steamer is turned on and the drain valve is in the closed position. Close the door and push the ON/OFF key on the keypad. The steamer will automatically fill and preheat.

Since the Evolution automatically senses the water level and refills as required. There is no need to manually fill the steamer.

PREHEATING

1. Depress the On/Off Key to turn on the steamer. The display will indicate PrE while in Cook Mode and the temperature while in the Hold Mode.
2. Once the steamer is preheated and ready to cook, the display will indicate the COO (Cook Mode) or HLd (Hold Mode).
3. Depress the DISP TEMP button to display the current cooking temperature.

COOKING

1. Depress the COOK/HOLD button to select the Cook Mode (COO).
2. Open the door and place food into the cooking chamber. Shut the door. Cooking begins immediately.
3. Timer — Depress the TIMER button and depress the ARROW keys until the desired time is displayed. The timer starts automatically. At the end of the timed cycle, a beeper will sound.
4. Depress the DISP TEMP button to display the current cooking chamber temperature.

HOLDING

In "Hold" the steamer temperature is set for 180° F from the factory. The hold temperature can be changed to a single value for temperatures ranging from 150°F to 190°F if required. Contact the AccuTemp Technical Service Department for assistance at 800.480.0415. Hold can also be used during downtimes to save energy and water while keeping the steamer preheated.

1. Depress the COOK/HOLD button to select the Hold Mode (HLd).
2. Open the door and place food into the cooking chamber. Shut the door.
3. Food will be held at the preset holding temperature. The factory setting is set at 180° F.
4. Depress the DISP TEMP button to display the current cooking chamber temperature.

4.5 Daily Preparation for Use - Connectionless Model

Preparing the Evolution Connection-Less model for use each day requires very little time and effort. Simply verify that the steamer is clean, the drain valve is in the closed position and the cooking chamber is filled with approximately 2½ Gallons of tap water. Close the door and push the ON/OFF key on the keypad. The water level will need to be monitored and filled as required. Do not use the low water warning lamp as the indicator to check the water level as this can damage the steamer over time.

PREHEATING

1. Depress the ON/OFF Key to turn on the steamer. The display will indicate PrE.
2. Once the steamer is preheated and ready to cook, the display will indicate COO (Cook Mode) or HLd (Hold Mode).
3. Depress the DISP TEMP button to display the current cooking chamber temperature. MAX temperature at sea level in 212°F

COOKING

1. Depress the COOK/HOLD button to select the Cook Mode (COO).
2. Open the door and place food into the cooking chamber. Shut the door. Cooking begins immediately.
3. Timer — Depress the TIMER button and depress the ARROW keys until the desired time is displayed. The timer starts automatically. At the end of the timed cycle, a beeper will sound.
4. Depress the DISP TEMP button to display the current cooking chamber temperature.

HOLDING

In "Hold" the steamer temperature is set for 180°F from the factory. The hold temperature can be changed to a single value for temperatures ranging from 150° F to 190° F if required. Contact the AccuTemp Technical Service Department for assistance at 800.480.0415. Hold can also be used during downtimes to save energy and water while keeping the steamer preheated.

1. Depress the COOK/HOLD button to select the Hold Mode (HLd).
2. Open the door and place food into the cooking chamber. Shut the door.
3. Food will be held at the preset holding temperature. The factory default setting is set at 180° F.
4. Depress the DISP TEMP button to display the current cooking chamber temperature.

4.6 Power Plate Setting



If using a Connection-less unit, do not adjust the power plate in the unit. It will affect the water evaporation ratio and cause the unit to be filled more regularly

The Power Plate has 3 settings:

- Batch - Factory Setting - Slowest Cook
- A la Carte
- Power Steam - Fastest Cook

Instructions to Adjust:

Tools Required

7/16" wrench or 7/16" socket wrench or adjustable wrench

Batch

1. Leave as received from the factory.

A la Carte

1. Remove the acorn nut and lock washer.
2. Remove the Power Plate and flip it so the larger size hole is lined up over the large vent hole.
3. Slide the Power Plate onto the stud and install the lock washer then the acorn nut and tighten.

Power Steam

1. Remove the acorn nut and lock washer.
2. Remove the power plate from the mounting stud.
3. Rotate plate so that the large rear vent is not covered by the plate.
4. Slide onto the stud and install the lock washer then the acorn nut and tighten.

FIGURE 19

Batch

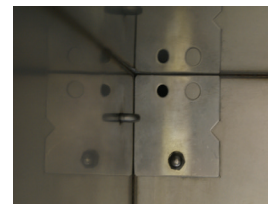

A la Carte



Power Steam



4.7 Cleaning



Do not use a water jet or pressure washer to clean the steamer.



After cleaning procedure is complete, steamer door must be left open to allow steamer to dry. Not doing so will decrease life of door gasket and accelerate corrosion.



If local water conditions cause rust inside the steamer or heavy mineral buildup, request the **AccuTemp Additional Cleaning Recommendations**.

4.7.1 Daily Cleaning - Connected

1. Close the drain valve and add 1 cup (8 ounces or 0.24 liters) of white vinegar to the cooking compartment. Start the steamer in the Cook Mode. The cooking compartment will automatically fill with water. After 15 minutes, turn the steamer off and allow the steamer to cool to 140°F or lower. Then open the drain valve and allow the water in the cooking chamber to drain completely.
2. Turn the steamer off and wait for the steamer to cool below 100° F
3. Open the drain valve and allow the cooking compartment to drain completely. Remove the pan racks, steam collector, overflow sensor and condensate tray for cleaning. Wipe the inside of the cooking chamber, pan rails, steam collector, overflow sensor, and condensate tray with a clean cloth (FIGURE 19). Clean the door gasket, inside of door and front face of the cooking chamber. Clean water sensors with a non metallic cleaning pad. Wipe down corners of cooking chamber
4. Re-install the overflow sensor, steam collector, pan rails and condensate tray. Leave the door open overnight.

(NOTE: The steamer will not operate without the overflow sensor. An alarm will also sound).

4.7.2 Daily Cleaning - Connectionless

1. Close the drain valve and add 1 cup (8 ounces or 0.24 liters) of white vinegar to the cooking compartment. Start the steamer in the Cook Mode. The cooking compartment will automatically fill with water. After 15 minutes, turn the steamer off and allow the steamer to cool to 140°F or lower. Then open the drain valve and allow the water in the cooking chamber to drain completely.
2. Turn the steamer off and wait for the steamer to cool.
3. Open the drain valve and allow the cooking chamber to drain completely. Remove the pan rails (FIGURE 19) and steam collector. Wipe the inside of the cooking chamber, water sensors, pan rails and steam collector with a clean cloth. Clean the door gasket, inside of door and front face of the cooking chamber.
4. Install the steam collector and pan rails. Once the water in the drain pan has sufficiently cooled empty the drain pan wipe down and replace. Leave the door open overnight.

4.7.3 Weekly Cleaning - Connected

1. Close the drain valve and add 1 cup (8 ounces or 0.24 liters) of white vinegar to the cooking compartment. Start the steamer in the Cook Mode. The cooking compartment will automatically fill with water. After 15 minutes, turn the steamer off and allow the steamer to cool to 140°F or lower. Then open the drain valve and allow the water in the cooking chamber to drain completely.
2. To rinse close the drain valve and start the steamer in the Cook Mode. The cooking compartment will automatically fill with water. After 15 minutes turn the steamer off and allow it to cool to 140°F or lower. Open the drain valve and let it drain completely.
3. Remove the cooking chamber components in this order: pan rails, steam distributor, steam collector, overfill sensor, power plate and dry them with a clean dry cloth.
4. Clean the water sensors with a non-metallic cleaning pad to remove any scale of debris left over after the cleaning process. Wipe with a clean dry cloth.
5. Wipe the inside of the cooking chamber with a clean dry cloth make sure to dry around the corners and seams of the cooking chamber (FIGURE 19).
6. Install the overfill sensor and the steam collector, resting the steam distributor on top of the steam collector align the 4 retaining fasteners and hand tighten, then install the pan rails and the condensate tray. Leave the door open overnight.

(NOTE: The steamer will not operate without the overfill sensor.)

4.7.4 Weekly Cleaning - Connection-less

1. Close the drain valve and add 1 cup (8 ounces or 0.24 liters) of white vinegar to the cooking chamber and fill with approximately 2½ Gallons of tap water, shut the door and turn the steamer on.
2. After 15 minutes, turn the steamer off and allow the steamer to cool. Open the drain valve and allow the cooking chamber to drain completely.
3. To rinse close the drain valve, fill with approximately 2½ Gallons tap water, close the door and start the steamer Cook Mode. Let it run for 15 minutes, turn the steamer off and allow the steamer to cool. Open the drain valve and allow the cooking chamber to drain completely.
4. Remove the pan racks, steam collector and steam distributor for cleaning. Clean the water sensors with a non-metallic cleaning pad. Wipe the inside of the cooking chamber, water sensors, pan rails, steam distributor and steam collector (FIGURE 19).
5. Install the steam collector first, resting the steam distributor on top of the collector align the (4) retaining fasteners and hand tighten and then install the pan rails. Leave door open overnight.

FIGURE 20

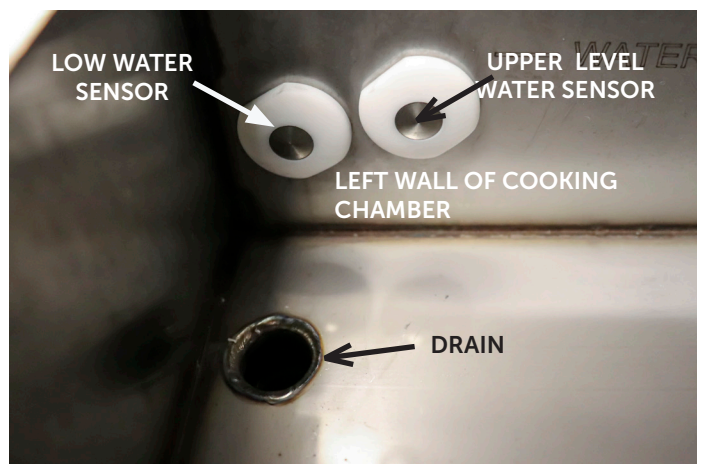

4.7.5 How to Protect Stainless Steel

All materials used in manufacturing AccuTemp products undergo multiple thorough quality inspections, as does the production process itself. For producing the internal parts of the appliance, AccuTemp uses high-quality steel. These are steels commonly indicated as corrosion-resistant or stainless, due to their heightened resistance to corrosion. The surface of these materials

is further treated during the manufacturing process (passivation or electromechanical polishing) to increase their corrosion resistance. However, improving these steels' corrosion resistance does not mean that corrosion can never occur at all.

If corrosion starts on these types of steel, there may be one or a combination of the factors listed below (it just takes a short time for corrosion to develop):

1. Using water that has:
 - a. High chloride or sulphate content (such as table salt NaCl, etc.)
 - b. High content of metals with opposite electrochemical potential.
 - c. High oxygen content (HNO₃, Cu²⁺, Fe²⁺).
 - d. pollutants (CO₂, H₂S, SO₂, iron).
 - e. High chlorine content.
 - f. High acidity.
 - g. Greater surface roughness due to improper cleaning.
2. Decreased possibility of natural passivation of material surface due to the presence of deposits:
 - a. of calcium (due to hard water).
 - b. of biological substances (food residues).
3. Surface contamination by iron (such as due to use of inappropriate cooking containers or cleaning with mechanical metal objects).
4. By use of unsuitable cleaning chemicals.

To protect the equipment, we would recommend the following steps:

1. Use the proper tools. Never use sandpaper on stainless steel, as it can cause scratches in the steel, allowing corrosion to form. Use non-abrasive tools, like soft cloths and plastic scouring pad, stainless steel pads (scrub in direction of polishing marks).
2. Clean with the polish lines or "grain" Scrub in a motion parallel to the lines when visible lines are present. Use a soft cloth or plastic scouring pad when grain cannot be seen.
3. Use alkaline, alkaline chlorinated or non-chloride containing cleaners. Ask your supplier for an alternative if your present cleaner contains chlorides. Avoid cleaners containing quaternary salts to avoid pitting and rusting.
4. Keep your food equipment clean. Following the cleaning instructions in Section 4.6 will greatly reduce the chances of corrosion and rust.
5. Rinse and wipe equipment and supplies if chlorinated cleaners are used, dry immediately. Wipe off standing water as soon as possible, especially when it contains cleaning agents.
6. Never use hydrochloric acid (muriatic acid) on stainless steel.
7. Regularly re-passivate with oxalic acid (Bar Keepers Friend or equivalent) or citric acid (Citri-surf / Citri-clean or equivalent) . Note – these materials are stronger and more effective than vinegar. These water based acids remove traces of steel and activate the chromium oxide passive layer.
8. Always rinse the unit with clean water and dry with the steamer door and drain valve open.

5. Troubleshooting

5.1 Steamer Will Not Power On

- Verify that the steamer is plugged into the proper outlet.
- Verify the the external breaker is on.
- If the 'High Water' warning light is on open the drain valve to drain the water until the light goes out.
- Verify that the float ball is in place.

5.2 Steamer Will Not Fill with Water

- Ensure water supply to unit is turned on.
- Clean two water sensors in cooking cabinet

5.3 Steamer is Overfilling with Water (Connected)

- Ensure unit is level.
- Clean two water sensors in cooking cabinet.

5.4 Steamer Does Not Heat

- If the operators display doesn't light up, see Section 5.1.
- Verify the steamer door is closed, as the unit will not heat when the door is open.

5.5 Steam Comes Out of Door (Overpressure)

- Verify that the door is completely closed and latched.
- Wait a minute to see if it stops. After the steamer refills with water it is normal for some steam to come out the door for a brief amount of time, usually less that one minute.

5.6 Steamer Temperature is Low

- When the steamer automatically refills the fresh water, the temperature of the steamer will drop. The steamer should reheat quickly.
- If -99F or -1F appears call AccuTemp for assistance.
- If frozen product is added the temperature will take time to recover.

5.7 Food is Undercooked

- Verify that the door is completely closed and latched.
- Opening and closing the door frequently can lower the temeperature and increase cook times.
- Verify the steam vent is clear of debris.
- Call AccuTemp for assistance with recipe timing.

If these don't solve your problem contact our Technical Service Department.

- **Hours: 7AM - 7PM EST 7 Days a Week (excluding certain Holidays)**
- **Phone - 800.480.0415 or 260.469.3040**
- **Email - service@accutemp.net**
- **Web site - www.accutemp.net**

SERVICE

INFORMATION

Conventional Steamers require scheduled maintenance (such as boiler maintenance) at frequent intervals) The Evolution design doesn't require this type of scheduled maintenance. It is recommended that you schedule a yearly review of the Evolution with a AccuTemp Authorized Service Representative to keep your steamer in optimal operation

INFORMATION

GENERAL SERVICE INFORMATION

All service request during the warranty period of this appliance must be directed to the AccuTemp Products, Inc. Technical Service Department or the service call may not be covered by the limited warranty.

WARNING

Only an AccuTemp Products Inc. Authorized Service Personnel or Representative must perform service. Service performed by unauthorized personnel will void all warranties.

INFORMATION

IMPORTANT SERVICE INFORMATION

AccuTemp Product, Inc. Technical & Customer Support Technician is available Monday thru Sunday, 7:00am to 7:00pm EST.

800.480.0415 or 260.469.3040

Email: service@accutemp.net

PREVENTATIVE MAINTENANCE

Note: Accutemp approved service providers should complete any tasks involving access to electrical systems.

PM TASK DESCRIPTION	DAILY	ANNUAL
Verify that the Steamer is level.	X	
Verify the operation of the control panel. When a button is pressed the display should register the input and a beep should sound.	X	
Verify the operation of the indicator lamps.	X	
Clean water fill sensors and overflow float with non abrasive metallic pad. DO NOT use sandpaper.	X	
(AUTO-FILL ONLY) Ensure unit fills with water to the water level line.	X	
Inspect external drain-lines for leaks. Repair if found.	X	X
Lubricate hinges and door latch with a food grade silicon spray	Monthly	
Lubricate stand casters	Monthly	
Inspect AC power cord for degradation or bare wires. Replace if defective or suspect		X
Inspect door gasket for cuts and degradation. Replace if damaged. We suggest replacing once a year.		X
Inspect Steam distribution panel gasket for cuts and degradation. Replace if damaged. We suggest replacing once a year		X
Inspect and clean steam vent, condensate line fittings and hoses.		X
Inspect the control compartment for foreign particulate and any loose wiring or connections.		X
Check Pressure Switch for correct operation. Recommend to replace every two years.		X
Inspect external and internal water connections and condensate lines for degradation and leaks. Replace as necessary		X

LIMITED WARRANTY

One Year– Parts and Labor

U.S. & Canada Only

AccuTemp Products, Inc. (AccuTemp) warrants that your AccuTemp equipment will be free of defects in material and workmanship under normal use for a period of twelve (12) months from installation or fifteen (15) months from date of shipment from AccuTemp, whichever date first occurs (the Warranty Period). Registration of AccuTemp equipment is required at the time of installation. Damage to AccuTemp equipment that occurs during shipment must be reported to the carrier, and is not covered under this warranty. The reporting of any damage during shipment is the sole responsibility of the commercial purchaser/user of such AccuTemp equipment.

AccuTemp provides an active service department, which should be contacted and advised of service issues, regardless of the warranty period. During the warranty period, AccuTemp must be contacted for warranty repairs and agrees to repair or replace, at its option, F.O.B. factory, any part which proves to be defective due to defects in material or workmanship, provided the equipment has not been altered in any way and has been properly installed, maintained, and operated in accordance with the instructions in the AccuTemp Owners Manual. During the warranty period, AccuTemp also agrees to pay for any factory authorized equipment service agency (within the continental United States and Canada) for reasonable labor required to repair or replace, at our option, F.O.B. factory, any part which proves to be defective due to defects in materials or workmanship, provided the service agency has received advance approval from AccuTemp factory service to perform the repair or replacement. This warranty includes travel time not to exceed two hours and mileage not to exceed 50 miles (100 miles round trip), but does not include post start-up assistance or training, tightening of loose fittings or external electrical connections, minor adjustments, maintenance, or cleaning. AccuTemp will not reimburse the expense of labor required to replace parts after the expiration of the warranty period.

Proper installation is the responsibility of the dealer, owner-user, or installing contractor and is not covered by this warranty. Improper installation can affect your warranty. Installation is the responsibility of the Dealer, Owner/User or the Installation Contractor. See the Installation section of the Owners Manual. While AccuTemp products are built to comply with applicable standards for manufacturers, including Underwriters Laboratories (UL) and National Sanitation Foundation (NSF), it is the responsibility of the owner and the installer to comply with any applicable local codes that may exist.

AccuTemp makes no other warranties or guarantees, whether expressed or implied, including any warranties of performance, merchantability, or fitness for any particular purpose. AccuTemp liability on any claim of any kind, including negligence, with respect to the goods and services covered hereunder, shall in no case exceed the price of the goods and services, or parts thereof, which gives rise to the claim. In no event shall AccuTemp be liable for special, incidental, or consequential damages, or damages in the nature of penalties.

This constitutes the entire warranty, which supersedes and excludes all other warranties, whether written, oral, or implied.



LIFETIME™
SERVICE & SUPPORT
1-800-480-0415 | service@accutemp.net



IMPORTANT SERVICE INFORMATION

AccuTemp Product, Inc. Technical & Customer Support Technician is available Monday thru Sunday, 7:00am to 7:00pm EST.

800.480.0415 or 260.469.3040

- Phone - 800.480.0415 or 260.469.3040
- Email - service@accutemp.net
- Web site - www.accutemp.net