

# EVOLUTION GAS STEAMER INSTALLATION & OPERATOR MANUAL

Connection-Less Model



Connected Model Double Stack



## IMPORTANT WARRANTY INFORMATION

WARRANTY REGISTRATION - STARTUP FORM INSIDE THIS MANUAL MUST BE REMOVED, COMPLETED, SIGNED BY CUSTOMER AND A COPY EMAILED, FAXED OR MAILED BACK TO ACTIVATE THE LIMITED WARRANTY.

**These installation instructions have been prepared for qualified gas and electric equipment installation personnel, who should perform the installation, initial field start-up and complete the equipment adjustments described in this manual.**

## **WARNING**

The State of California enacted the California Safe Drinking Water and Toxic Enforcement Act of 1986, (Prop. 65), which “prohibits any person in the course of doing business from knowingly and intentionally exposing any individual to a chemical known to the State of California to cause cancer or reproductive toxicity without first giving clear and reasonable warning to such individuals.” The Governor’s Scientific Advisory Panel added Carbon Monoxide to the list of hazardous chemicals known to cause reproductive harm.

In order to establish full compliance with Proposition 65, a yellow warning label has been attached to each gas fired unit manufactured by AccuTemp Products, Inc.

Carbon monoxide would not be present in concentrations that would pose a “significant risk” to the consumer when the equipment is installed, operated and maintained as follows:

1. Installed in accordance with all local codes, or in the absence of local codes, with the current National Fuel Gas Code Z223.1, latest addenda.
2. Installed under a properly designed and operating exhaust hood.
3. Connected to the type of gas for which the unit is equipped.
4. Proper appliance pressure regulator installed on the gas supply line and adjusted for the manifold pressure marked on the rating plate.
5. Adequate air supply to the unit and adequate clearance around the flue.
6. The equipment is operated in the manner intended using the proper utensil for that type of appliance.
7. Keep the equipment clean and have it checked periodically.
8. Burner air adjustments, mechanical maintenance and repairs should be performed by qualified service personnel.

## TABLE OF CONTENTS

SAFETY WARNINGS INFORMATION	PAGE 2
START UP FORM	PAGE 3
GENERAL INFORMATION	PAGE 5
INSTALLATION	PAGE 7
OPERATION - USE	PAGE 15
OPERATION - CLEANING	PAGE 18
TROUBLESHOOTING	PAGE 21
SERVICE	PAGE 22
PREVENTATIVE MAINTENANCE CHECKLIST	PAGE 23
WARRANTY	PAGE 24

## DOCUMENT HISTORY

CURRENT REVISION	DATE	PRIOR REVISION	DATE	CHANGE
2302	02/20/2023	1809	09/05/2018	Adjusted NG gas pressure.
1809	09/05/2018	1003	04/14/2010	Review and update of manual

# **IMPORTANT FOR YOUR SAFETY**

The safety instructions listed below on this page should be posted in a prominent location as a reminder of safe practices as well as recommended actions to follow in the event of an equipment or facility utility issue.

## **WARNING**

In the event a gas odor is detected, shut down all appliances at the main gas shut-off valve and contact the local gas company or gas supplier service.

## **WARNING**

In the event of a power failure, do not attempt to operate this appliance.

## **WARNING**

Do not store or use gasoline or other flammable vapors or liquids in the vicinity of this or any other appliance.

## **WARNING**

Improper installation, adjustment, alteration, service or maintenance can cause property damage, injury or death. Read the installation, operating, and maintenance instructions thoroughly before installing or servicing this equipment.

## **WARNING**

Only qualified service technicians/electricians should install this appliance to ensure that all electrical and safety requirements are met and that all wiring is installed in accordance with all national, state and local electrical codes.

<b>SERIAL NUMBER:</b>	<b>MODEL NUMBER:</b>
-----------------------	----------------------

Location Name: <input style="width:95%;" type="text"/>	Date: <input style="width:95%;" type="text"/>
Street Address: <input style="width:95%;" type="text"/>	Service Company: <input style="width:95%;" type="text"/>
State/ Zip Code: <input style="width:95%;" type="text"/>	Street Address: <input style="width:95%;" type="text"/>
Building Name/#: <input style="width:95%;" type="text"/>	State/ Zip Code: <input style="width:95%;" type="text"/>
Contact Name: <input style="width:95%;" type="text"/>	Service Phone #: <input style="width:95%;" type="text"/>
Phone: <input style="width:95%;" type="text"/>	Technicians Name: <input style="width:95%;" type="text"/>
Email: <input style="width:95%;" type="text"/>	Technicians Email: <input style="width:95%;" type="text"/>
	Additional Info: <input style="width:95%; height: 40px;" type="text"/>

- AccuTemp Products, Inc. is not responsible for the installation and/or modifications to the electrical or gas supply sources.
- It is recommended that the wall receptacle be placed as low as State and Local codes allow. Placement in high heat zones such as, just above, below or beside the exhaust flue, will cause service issues that will not be covered under the product warranty.
- An external regulator should not be used unless the supply gas pressure is more than 0.5 psig/14"WC
- If the altitude is greater than 2,000 feet above sea level, contact the AccuTemp Technical Services Department to verify the correct orifice size for main burner.

This Start-Up Form must be completely filled out, emailed, faxed or mailed or emailed to the AccuTemp Technical & Customer Support Department, before the warranty is activated.

	YES	NO
1. Is the steamer being installed at an altitude greater than 2,000 feet (Tick Box)	<input type="checkbox"/>	<input type="checkbox"/>
2. Is an external gas regulator connected to the steamer (Tick Box)	<input type="checkbox"/>	<input type="checkbox"/>
3. Is the steamer level? (Tick Box)	<input type="checkbox"/>	<input type="checkbox"/>
4. If the steamer has legs, have the (4) rubber foot tips been installed (Tick Box)	<input type="checkbox"/>	<input type="checkbox"/>
5. Is the steamer hard connected to the gas supply line? (Tick Box)	<input type="checkbox"/>	<input type="checkbox"/>
6. If the steamer is connected with a 3/4" flexible commercial grade gas hose? (Tick Box)	<input type="checkbox"/>	<input type="checkbox"/>
7. If yes, is a restraining device used? (Tick Box)	<input type="checkbox"/>	<input type="checkbox"/>

AccuTemp Products, Inc  
 Attn: Technical & Customer Support Department  
 11919 John Adams Dr  
 Fort Wayne IN 46774

Phone: 260.469.0415 or 800.480.0415

Fax: 260.493.8914

Email: [service@accutemp.net](mailto:service@accutemp.net)

**EVOLUTION Gas Steamer Start-Up Form (continued)**

8. What is the Lenth and Width of the Gas Supply Line L_____ W_____
9. Gas Pressure measurements Natural Gas: Static____WC Dynamic____WC (Dynamic should be 3.5WC) Dynamic pressure should be 3.5"WC (Regulator valve pressure tap - 1/8NPT) Propane: Static____WC Dynamic____WC (Dynamic should be 10WC) Dynamic pressure should be 10"WC (Regulator valve pressure tap -1/8NPT)
10. What is the measured flame sense on the unit? _____uA (microampere)
11. At what mark is the Blower Motor air shutter set to? _____

Connected Models Only

YES NO

12. (For connected models) Is the supply water pressure lower than 30PSI (Tick Box)	<input type="checkbox"/>	<input type="checkbox"/>
13. (Connected models) With the Steam Collector Pan removed and the Steam Chamber empty, does the Auto-Fill Water Stream hit the chamber floor half-way to three-quarters of the way towards the opposite wall? Note: If the Auto-Fill Water Stream is slamming against the opposite wall, then the water pressure is too high and will need to be adjusted at the supply water shut-off valve, to the above parameters.	<input type="checkbox"/>	<input type="checkbox"/>
14. Is the Float Ball Installed in the unit?	<input type="checkbox"/>	<input type="checkbox"/>
15. Is there a High Water alarm when the Float Ball is removed?	<input type="checkbox"/>	<input type="checkbox"/>

16. Does the Low Water Light and Alarm turn OFF once the chamber water level has reached the middle of the Low Water Sensor? (Connected Water Models will only have the Low Water Light and no Alarm.)	<input type="checkbox"/>	<input type="checkbox"/>
17. Has additional piping been added to the steam vent? (Tick Box)	<input type="checkbox"/>	<input type="checkbox"/>
18. Does the steamer operate when all gas appliance in the kitchen are operating? (Tick Box)	<input type="checkbox"/>	<input type="checkbox"/>
19. Verify the water temperature in COOK MODE (COO on digital display) _____°F		
20. Does the unit cycle the heat once it is in COOK MODE? (Tick Box)	<input type="checkbox"/>	<input type="checkbox"/>
21. Is there any added drain hose/piping attached to the Steamer Drain System? Note: Does the added drain hose/piping to the steamer meet the specifications listed on the instruction label attached to the back of the steamer?	<input type="checkbox"/>	<input type="checkbox"/>
22. Take photographs of install, including: Front of steamer, Side view of steamer, Gas hook up and supply.	<input type="checkbox"/>	<input type="checkbox"/>

I accept this Start-up form as complete and accurate:

Signed: \_\_\_\_\_ Restaurant Management Date: \_\_\_/\_\_\_/\_\_\_

Print Name: \_\_\_\_\_

## 1. GENERAL INFORMATION

AccuTemp appreciates your decision to purchase our equipment. Your new equipment combines the long-term experience of the best chefs together with the latest scientific and modern technologies. With the help of your new equipment, you shall always achieve the highest quality dishes and a superior product. To ensure that you succeed right from the beginning in gaining the best results, we would like to provide you, through this manual, with all the information necessary for smooth operation.

AccuTemp guarantees proper functioning and high-quality service.

We offer:

- 12-month guarantee of flawless operation of the equipment.
- Warranty service and post-warranty support.
- Technical and advisory services in connection with servicing and maintenance.
- Chef expert advisory service.

We hope that you enjoy working with AccuTemp equipment and that you always have many satisfied guests.

**This manual contains available information on the AccuTemp equipment accessible at the time of publication of this manual. Errors and technical modifications are under the usual provision.**

### 1.1 Contact

Should you have any questions we are at your service at the following telephone numbers and addresses.

AccuTemp Products  
11919 John Adams Dr  
Fort Wayne, IN 46774

Tel: 800 480-0415  
Fax: 260 469-3045  
E-Mail: [service@accutemp.net](mailto:service@accutemp.net)

### 1.2 Use of the operating instructions

Read carefully and follow the instructions for operation and maintenance of your equipment. Should some of the procedures be unclear, contact your salesperson for further assistance.

#### SYMBOLS USED

The symbols used here draw attention to activities that may influence safety, health protection and the necessity for servicing. They help you to prevent problems and the advice will make your work easier.



#### WARNING

Indicates a potentially hazardous situation; which, if unchanged, will result in death or serious injury.



#### CAUTION

Indicates a potentially hazardous situation; which, if unchanged, will result in minor or moderate injury



#### NOTE

Advises reader of information or instructions vital to the operation or maintenance of the equipment



#### EARTH GROUND



#### DANGEROUS VOLTAGE



#### HOT SURFACE

### 1.3 Warranty Restrictions

All the technical information, data, operation and maintenance instructions contained in this operating manual correspond to the final state upon delivery and were compiled with regard to our previous experience and to our best knowledge. We reserve the right to carry out technical changes on the equipment described in this operating manual as part of further development of the equipment.

We do not accept any responsibility for any damage or failures arising from incorrect operation, lack of attention to this manual, use of aggressive chemical cleaning products and technically incorrect repairs. We call your attention to the fact that this also applies to spare parts not delivered by us and to accessory equipment not pre-tested and approved by us.

All modifications or changes made to the equipment through your own efforts are not permitted for the reasons of safety and relieves AccuTemp of any responsibility for damage arising there from. Within the scope of the warranty obligations negotiated in the contract under the exclusion of further claims, we accept responsibility for accidental mistakes or neglects.

Claims for reimbursement for damages are not possible regardless of upon what judicial reason such claim is made.

## 2. EQUIPMENT DATA PLATE

### 2.1 Labeling

Model: **A B CCC D E FFF G H I J K**

Where:

**A** is the base model N = Natural Gas, P = Propane

**B** is the size of the unit: 6 pan

**CCC** is the supply Voltage

**D** is the number of phases: 1 or 3

**E** is the control series D=Manual Fill, E=Autofill

**F** is the energy input

**G** is the timer configuration

**H** is the thermostat configuration

**I** is the door configuration

**J** is the leg configuration

**K** is the HDW configuration

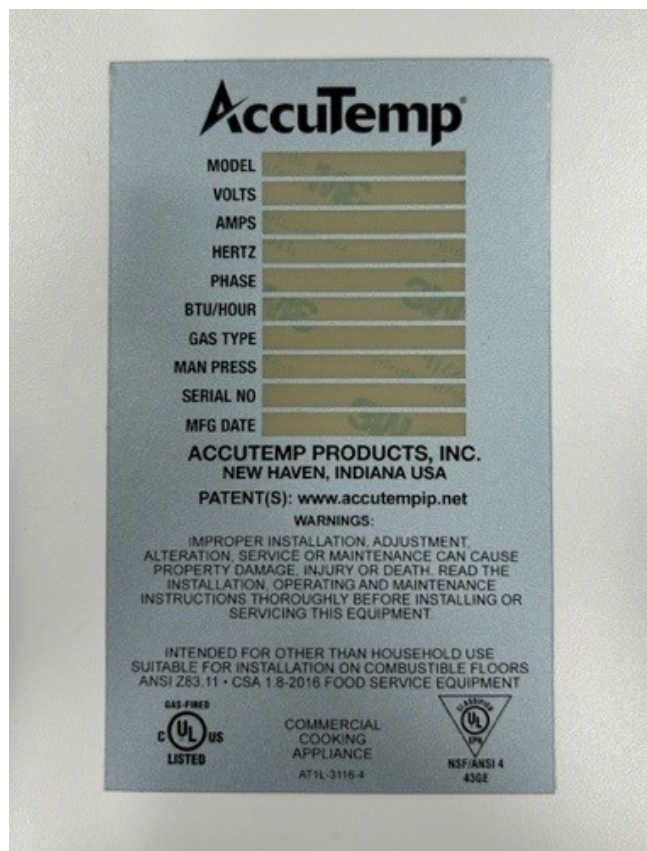



## 3 INSTALLATION

### 3.1 Installation Notice

Only qualified service technicians/electricians should perform the installation to ensure that all electrical, gas and safety requirements are met and that all wiring, gas and plumbing installations are performed in accordance with all national, state and local codes.

The installation must conform with local codes, or in the absence of local codes, with the National Fuel Gas Code, ANSA/NFPA 54, or the Natural Gas and Propane Installation Code, CSA B149.1 as applicable.

The appliance and its individual shutoff must be disconnected from the gas supply piping system during any pressure testing of that system at test pressures in excess of 1/2 PSI(3.5kPA)

### 3.2 Unpacking

This appliance was carefully inspected before shipment from the factory. The transportation company assumes full responsibility for safe delivery to the customer until customer acceptance of the package. Careful inspection of the packaging and the appliance should be completed before acceptance from the transportation company.

### 3.3 Steamer Lifting

Steamers are heavy enough to require additional manpower or powered assistance when installing or moving the steamer.

 When moving the equipment manually make sure there are enough people for the task as the equipment is heavy.

 Make sure the equipment is not dropped during moving. People doing the carrying could be seriously injured and/or the equipment damaged. The manufacturer does not accept any responsibility for damage resulted from such actions.

### 3.4 Location and Placement

The AccuTemp Evolution gas steamer can be placed on a commercial kitchen counter-top, flush mounted or installed on an AccuTemp Evolution gas steamer stand. Provisions should be incorporated in the kitchen to ensure an adequate supply of fresh air for proper combustion and ventilation (FIGURE 1).

The steamer must be installed in a level condition. An out of level condition may cause erratic operation and damage to the steamer. Damage of this kind is not covered by the limited warranty. Use a spirit level resting on the top surface of the steamer to ensure it is level front to back and left to right.

 For the correct operation of the steamer it is important that it is leveled in a horizontal position.

 Placement on an unlevel or uneven surface may result in performance faults. Only professional installation of the device guarantees it high-quality operation.

 Check proper setting of the equipment by placing a hotel pan filled with water inside the steamer and observing the water level.

 A minimum clearance of 10 inches must be allowed for on the left hand side of the unit for maintenance access to the unit. Failure to provide this may limit the effectiveness of service dispatch and incur additional costs not covered by warranty.

FIGURE 1: EQUIPMENT CLEARANCE INFORMATION

FOR COMBUSTIBLE & NONCOMBUSTIBLE BUILDING MATERIALS

LOCATION	COMBUSTIBLE	NONCOMBUSTIBLE
SIDES	1"	0"
REAR	2"	0"

FOR OTHER SOURCES OF HEAT: FRYERS, OPEN RANGE, STEAM VENTS. For open flame, this is the minimum distance from the flames while they are in operation.

LOCATION	
LEFT	3"
RIGHT	3"
REAR	3"

### Counter Top Placement

In a counter top installation the steamer can be leveled using the adjustable legs. Once this is complete it is required that the supplied (4) rubber foot tips be installed to keep the steamer from possibly sliding on the counter top under normal use.

### 3.5 Stand Installation

If an AccuTemp Evolution Gas Steamer Stand is used ensure the floor is level and place the two locking casters to the "ON" position.

All AccuTemp Evolution Gas Steamer Stand with casters, shall be made with a connector that complies with the Standard for Connectors for Movable Gas Appliances, ANSI Z21.69 or CAN/CGA 6.16 and a quick disconnect device that complies with the Standard for Quick Disconnect Devices for Use with Gas Fuel, ANSI Z21.41 or CAN1-6.9.

 When using a stand that is equipped with casters, the floor surface must be level and flat. Failure to do so can result in a "tipping" hazard that could result in serious injury.

#### 3.5.1 Single Steamer Stand Installation Instructions

The AccuTemp single stand can be equipped with adjustable height feet or non-adjustable casters (FIGURE 3).

1. Before mounting a steamer on the stand with casters, engage the two front locking casters, pressing on the "ON" handle of the brake mechanism.
2. To mount the steamer, carefully lift and place it on the horizontal mounting brackets ensuring that the (4) mounting holes on the underside of the Evolution are lined up with mounting holes of the brackets.
3. Then, using a 7/16" wrench, fasten one pair of the 1/4" -20 hex bolt and 1/4" split lock washer through the underside of each stand bracket mounting hole into the Evolution and tighten securely.
4. With the SNH-10 stand, level the steamer by adjusting the feet found at the ends of each stand leg, either up or down as needed.

 When installing units on a double stand, always install the lower unit first. Installing the upper unit first could cause the stand to topple.

### 3.5.2 Double Stand Installation Instructions

The AccuTemp double stand can be equipped with adjustable height feet or can be equipped with non-adjustable casters and accommodates (2) N6 model Evolutions (FIGURE 4).

1. Before mounting a steamer on a stand with casters engage the brakes on the two front locking casters, pressing on the "ON" handle of the brake mechanism.
2. Always mount the first EVOLUTION on the bottom of the stand. To mount the bottom steamer, carefully lift and place it on the horizontal mounting brackets, ensuring that the (4) mounting holes on the underside of the Evolution are lined up with the mounting holes on the brackets.
3. Then, using a 7/16" wrench, fasten one pair of the 1/4"-20 hex bolts and 1/4" split lock washers through the underside of each stand bracket mounting hole into the Evolution and tighten securely.
4. Once the bottom steamer has been installed, carefully lift and place the top Evolution steamer on the horizontal mounting brackets, ensuring that the (4) mounting holes on the underside of the Evolution are lined up with the mounting holes on the brackets.
5. Then, using a 7/16" wrench, fasten one pair of the 1/4"-20 hex bolts and 1/4" split lock washers through the underside of each stand bracket mounting hole and tighten securely.
6. With the SNH-20 stand, level the appliances by adjusting the feet found at the ends of each stand leg, either up or down as needed.

### 3.5.3 Flush Mount Installation

To Flush mount the appliance to a counter, follow these steps:

1. Drill 4 holes as seen in FIGURE 2.
2. Attach the appliance to counter top with (4) 1/4-20 x 3/4" hex head bolts and 1/4-20 split lock washers.
3. Apply a bead of high temp food grade silicone caulking around the perimeter and smooth out.

FIGURE 3: MANUAL FILL UNIT ON SINGLE STAND



FIGURE 4: AUTOFILL UNITS ON A DOUBLE STAND



FIGURE 2

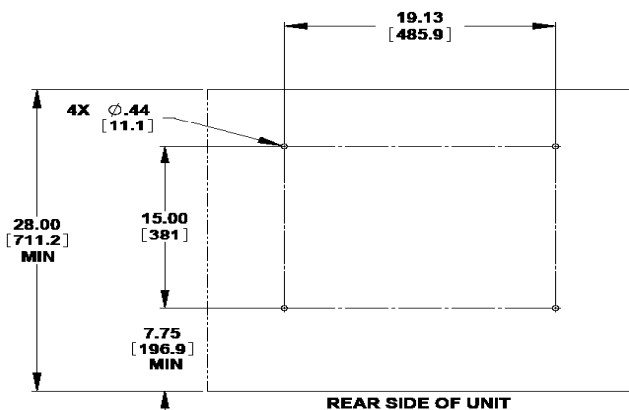

### 3.6 Steamer Connections

The Evolution Gas Steamer is available in a connected and connection-less models.

Both the connection-less and connected model will require a gas connection and an electrical connection.

#### CONNECTED UNITS:

The connected model in addition to the gas and electrical connection will require a water connection and access to a floor drain or sink to route a drain hose (not supplied) to allow condensate to be removed and to drain the steamer when required.

See FIGURE 5 for identifications of the required steamer connections.

#### CONNECTIONLESS UNITS:

This model must be manually filled with tap water and must be filled throughout the cooking process to assure consistent cook times.

 Do not use the "Low Water Indicator" as your indication that this steamer requires water as this actually turns off the heat to the product thus stopping the cooking process.

 A full size steam table pan or a 1/1 gastronome pan must be installed in rails under the steamer any time the steamer is operating and anytime that the steamer is being cleaned or drained of the water in the cooking chamber. Failure to follow this directions will cause a the steamer to fail which is not covered under the limited warranty (FIGURE 6).





FIGURE 6: MANUAL FILL UNIT ON SINGLE STAND



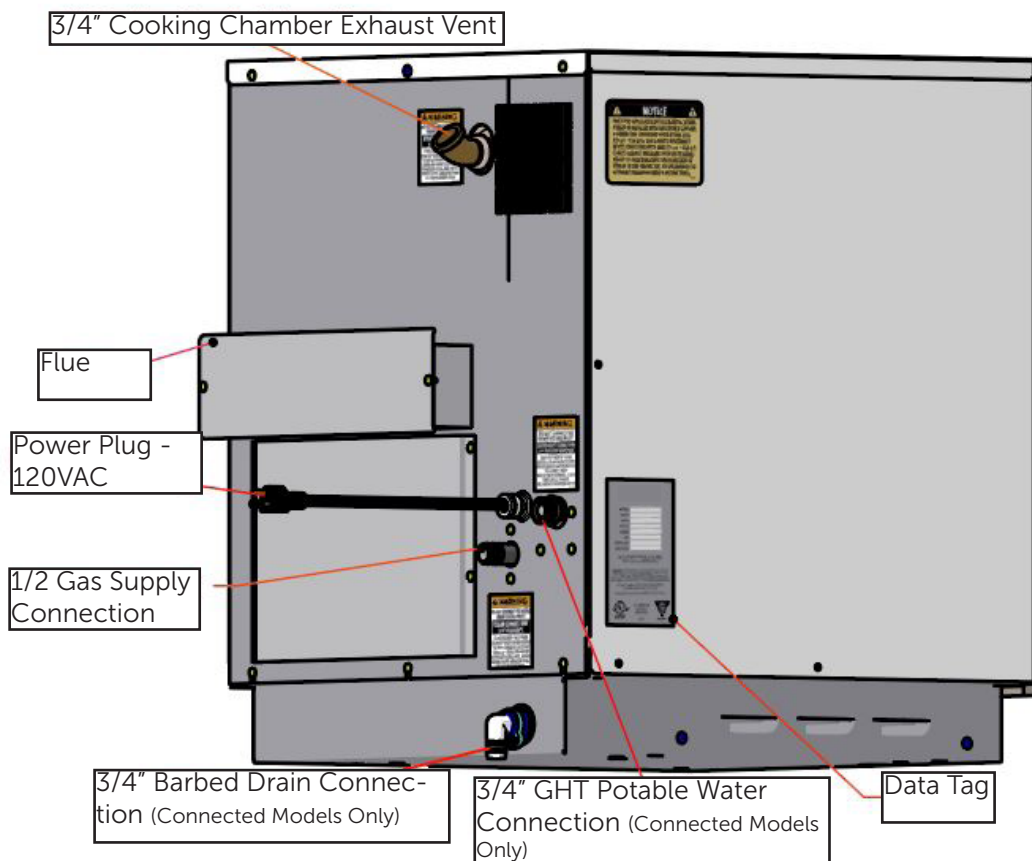





FIGURE 5 - TEXT ENCIRCLED BOLD ARE SHARED CONNECTIONS BETWEEN BOTH MANUAL AND AUTO-FILL UNITS



### 3.7 Electrical Requirements and Notices

-  The electrical voltage requirement is listed on the data plate that is located on the lower left side panel.
-   All AccuTemp Evolution Gas Steamers are supplied with a power cord and plug that must be connected to a standard a 15A (120V) or 20A (240V) grounded receptacle.
-  Make sure the voltage is within 10% of the voltage listed on the steamer data plate.
-  Connection to any other voltage not identified on the data plate will cause damage to the components and is not covered under warranty.



Grounding provides a path for electric current to reduce risk of shock.

-  This product is equipped with a power cord having a grounding plug.
-  The plug must be plugged into a receptacle that is properly installed and grounded in accordance with all National, State and local electrical codes or in the absence of local electrical codes with the National Electric Code, ANSI/NFPA 70, or the Canadian Code, CSA C22.2 as applicable.
-  Under no circumstances shall the plugs grounding prong be cut or bent to fit a receptacle other than the one specified.
-  Do not use any adapters.
-   Any in-field modification made that bypass the safety features of this appliance will result in serious injury or death. **DO NOT DIRECT WIRE THIS APPLIANCE.**
-  Any in-field modifications made without written authorization from AccuTemp Products, Inc. will void all written and oral warranties.

### 3.8 Gas Connections



#### 3.8.1 Gas Requirements and Notices

The Evolution Gas Steamer is manufactured for the use of gas indicated on the data plate. Contact AccuTemp Products Technical Service Department if your gas supply does not match the gas indicated on the steamer data plate.

-  MINIMUM recommended static pressure for gas is: NG 7inWC, LP 10inWC.
-  All gas connectors must be in accordance with the local codes and must comply with the latest edition of the National Fuel Federal Gas Codes, ANSI Z223.1.
-  A separate gas shutoff valve (not supplied) should be installed in the gas supply line. Use a 3/4" or larger diameter dedicated **commercial grade** gas supply line capable to handle a minimum of **60,000 BTU** to connect this steamer to the facility supply manifold to ensure a sufficient volume of gas.

The facility supply regulator and manifold must be sized according to the gas load of all appliances connected to it. If

other gas appliances are connected to the supply manifold, their gas load must be added to the calculations for properly sizing the supply manifold and regulator.

-  Flexible residential appliance connection hoses are not suitable for this appliance and will void any warranty.
-  If your steamer is located at an altitude of 2000 feet or higher, the orifice must be changed to allow appropriate gas supply to the burners. Please contact the AccuTemp Products Technical Services Department for assistance.

 The steamer is supplied with an internal gas regulator that is for the gas type and pressures on the steamer data plate. An external regulator is not required unless the gas supply pressure is more than 0.5psig. If an external regulator is required it must be rated 125% of the steamer BTUH rate at the pressure higher than the rated regulated pressure.

#### 3.8.2 Gas Pressure Verification

 The gas supply pressures for the internal regulator must be verified with a calibrated manometer while the appliance is operating in maximum load condition.

A 1/8" NPT tap is provided in the front of the internal regulator to measure the burner STATIC pressure, see FIGURE 7. Use a pipe joint compound or sealant designed for the use with liquefied petroleum gas when replacing the 1/8" NPT tap.

 Do not use an excessive amount of sealant in order to prevent potential obstruction of the gas control valve.

#### 3.8.3 Gas Pressure Adjustment Instructions

1. Ensure unit is connected to gas supply.
2. Turn gas off at supply.
3. Remove 1/8" NPT plug from dual solenoid control valve.
4. Use a 1/8" NPT tap to connect a manometer to the control valve. Ensure manometer is set to read inches water column.
5. Turn supply on and power unit on.
6. When unit powers on, the pilot valve will open and the STATIC pressure will be present.
7. Once unit attempts ignition, the main valve will open and the DYNAMIC pressure will register on the manometer.
8. The DYNAMIC pressure must be set to **NG:3.5 inch WC. LP 10 inch WC.**
9. To adjust the pressure, remove the dust cap on the regulator as seen in Figure 7.
10. Adjustment screw can be turned using a slot head screwdriver. Adjust while burner is on.

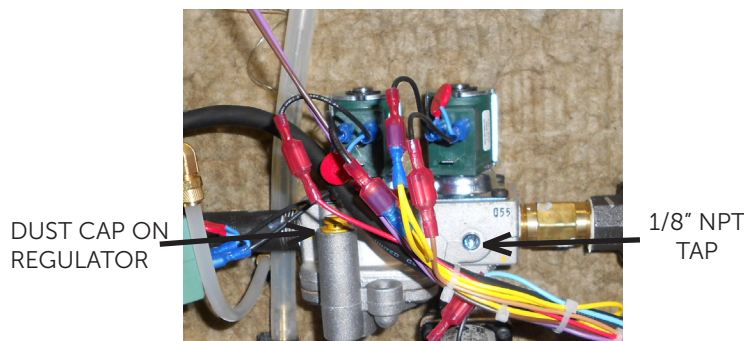

### 3.8.4 Flame Sense Rectification

The Evolution Gas Steamer utilizes a flame sensing circuit to determine if the system has proper combustion. When the system is turned on, gas is sent to the burner and an electronic ignition tries to ignite the burner. The ignition module then checks to see if flame is established in the burner.

If the flame sense feedback is within the proper range the system will stay on until the pressure switch opens. The ignition module continues to monitor the voltage and as long as its within the proper range the burner will stay on. If the flame sense reading falls below the threshold of 2.5uA (microamperes) the steamer will go into lock out and will stop heating. There is no exterior signal for a lockout.

1. The flame sense should be monitored and recorded as part of the install.
2. To test for flame sense, connect a multimeter to the FC+ and FC- pins on the ignition module (FIGURE 8). Set the multimeter to test for microampere.
3. Run the unit and monitor the reading.
4. If the gas pressure is set correctly for the gas type the reading should be 4 to 6  $\mu$ A (Micro Ampere)
5. The air intake shutter is factory set to a value of 2.5 to 5. The gap has been pre-set at the factory for best combustion performance (FIGURE 9).

FIGURE 8  
FC + & FC -

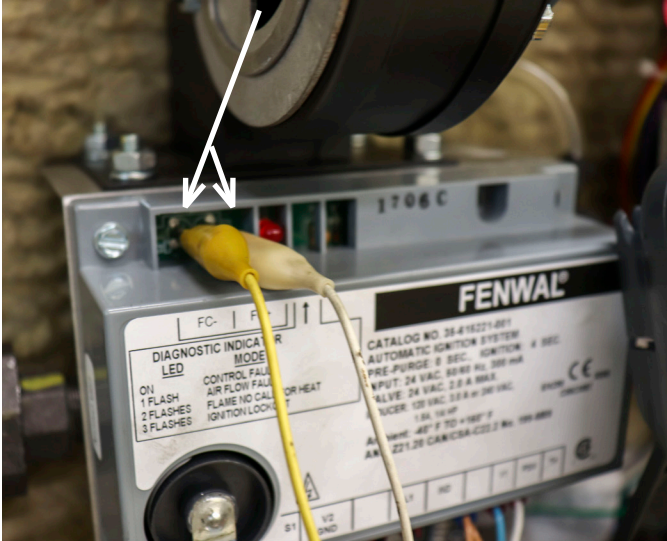
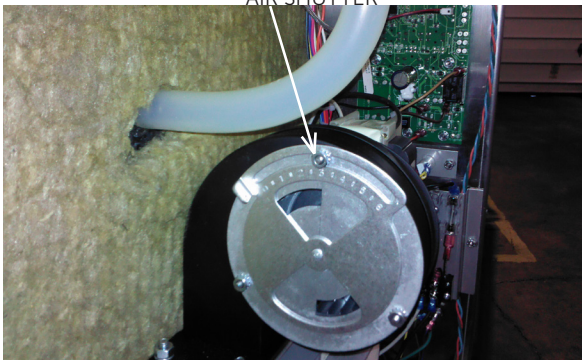



FIGURE 9  
AIR SHUTTER



### 3.9 Connected Model - Additional Connections

#### 3.9.1 Supply Water Line (FIGURE 10)

 The installation of the water connection to the appliance is the responsibility of the owner and or installer.

 The installation of this appliance should comply with all applicable federal, state or local plumbing codes.

 The installation requires a check valve (or other approved anti-back flow/ anti-siphon device) in all supply lines in accordance with and as required by local, state and national health, sanitation and plumbing codes. AccuTemp does NOT provide a check valve included with the steamer.

- Design the water supply line so the unit can be moved for service. Install a manual water valve between the water supply line and the steamer supply line.
- A reinforced rubber or braided stainless steel appliance hose rated for the temperature and pressure of the water supply with a 3/4" garden hose type connection is required.
- The Garden Hose Thread (GHT) connector used must be suitable for potable water
- Do not apply pipe thread sealant to GHT connections.
- Install a manual water shut-off valve (not provided) between the cold water supply line and the appliance.
- Either hot or cold water can be connected to the steamer. If hot is used, temperature must be less than 180°F.
- The hose must not be sharply bent, kinked or twisted.
- If the steamer is close to a wall, use a right angle fitting to prevent kinking the hose
- Flush the water supply lines before connecting the lines to the appliance.
- Connect the water supply lines to the steamer.

#### 3.9.2 Drain Line Connection

##### Floor Drain

 The steamer should be located close to, but not within 20" or directly over, a floor drain.

- Connect a 3/4" ID reinforced rubber hose rated for 212°F or higher to the drain fitting on rear of the steamer with a hose clamp.
- Run the hose to the drain. DO NOT directly plumb the steamer to the drain, Leave a one-inch air gap between the hose and the drain.
- The hose must drop 1/4" (inch) per foot to the drain.
- Ensure no loops form in the drain line as this can cause a backup and will affect the operation of the unit

 The unit should not be located within 20" of a floor drain.

##### Optional Drain Connection

Run the hose to a funnel fitting leaving a one-inch gap between the hose and the top of the funnel. The drain hose must slope toward the floor drain or funnel.

FIGURE 10

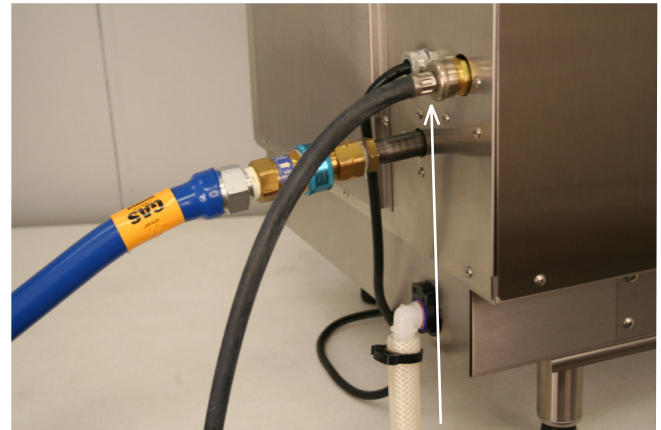

WATER INLET

FIGURE 11





DRAIN CONNECTION  
CONNECTED STEAMERS ONLY

### 3.10 Ventilation

 The steamer produces water vapor along with the extremely hot products of combustion.

 The flue should not be obstructed or blocked in any way. Any in-field modifications made without written authorization from AccuTemp Products, Inc. will void all written and oral warranties.

 DO NOT connect Drain or Vent lines on multiple appliances. Each appliance should have its own dedicated drain and vent.

 The steam vent is provided with a 45 ° elbow. The steam vent must not be obstructed. An obstruction will prevent correct operation of the steamer.

 Applicable federal, state and/or local plumbing codes will dictate when and if a hood is required.

 When installing a gas fired appliance in any location, provisions should be made for adequate make up air. Additionally the appliance should not be positioned in locations where the appliance is subject to drafts.

 Do not permit fans to blow at the appliance, and wherever possible, avoid open windows near to the sides and back of the appliance. Check wall fans to make sure air cross currents are not created in the room.

#### 3.10.1 Steam Vent Extension

When adding anything to the vent on the Evolution steamer, care must be taken to prevent doing anything that puts a back pressure on the steamer. Back pressure on the steamer may interfere with the pressure switch that controls the heaters. When the pressure switch senses pressure in the steamer is 0.5" of water or more, it turns the heaters off. Therefore, anything on the vent putting a pressure of just 0.5" water column on the steamer turns the heaters off and prevents them from coming on again until the pressure is relieved. Intermittent operation of the steamer can often be traced to restrictions, low spots or a plugged condensate drain in the vent fitting assembly.

To prevent putting a back pressure on the steamer, vent piping should have no restrictions and no low spots where water can accumulate. Ventilation piping can be directed upwards toward hoods or downward towards floor drains. Slightly different approaches are required for each application.

#### Extension Sloping Upward (FIGURE 12)

1. Use nominal 3/4" copper, brass or stainless steel to prevent flow restrictions. Larger inside diameter (ID) can be used also
2. Pipe should slope upward a 1/4" per foot from the steamer vent toward a vent hood to allow water condensing in it to run back to the steamer and down the drain line. Minimum

recommended slope is 1/4" per foot of hose length.

3. Use rigid pipe rather than flexible tubing or hose to prevent dips or sags in the pipe that may collect water. A puddle of water in the piping just 1/2" deep will cause the steamer to malfunction. Recommended pipe materials are rigid 3/4" copper tubing (7/8" OD) or brass/ 18-8 stainless steel pipe (3/4 NPT or larger). Pipe hangers or pipe supports should be used every six feet to prevent long runs from sagging.
4. A pipe union should be installed next to the steamer to permit the vent to be easily disconnected. This allows the steamer to be easily moved for servicing.
5. Total length of extended vent piping should not exceed 15 feet.

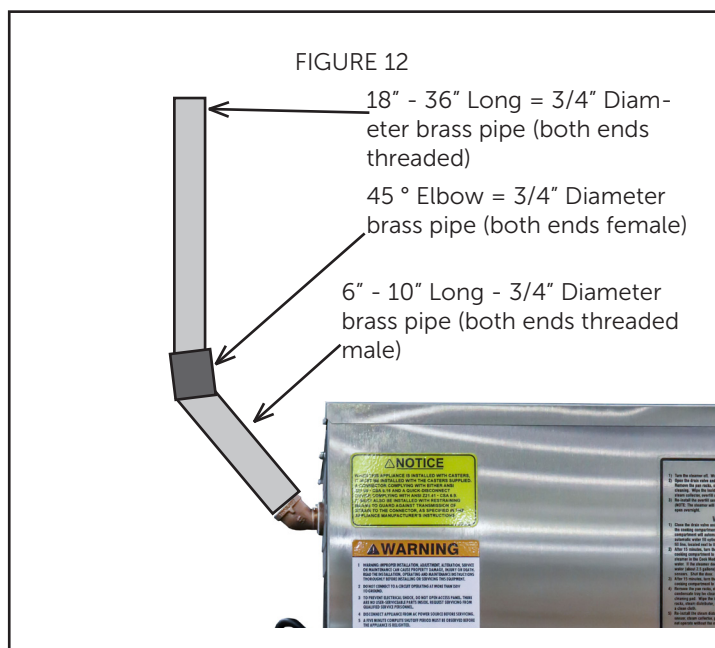

**Extension Sloping Downwards (FIGURE 13)**

1. Use nominal 3/4" or larger inside diameter (ID) to prevent flow restrictions.
2. Pipe should slope downwards from the steamer vent to a floor drain to allow water condensing in it to run unimpeded into the floor drain.
3. For downward sloping extension to a floor drain ONLY – 3/4 ID or larger reinforced silicone hose (auto radiator hose) may be used. The hose end must be open and not submerged. Avoid any low spots that will cause puddles of water and increase of back pressure.
4. Total length of extended vent piping should not exceed 15 feet.

**Mounting vent Extensions On Two Steamers on a Double Stack Stand.**

**!** DO NOT connect Drain or Vent lines on multiple appliances. Each appliance should have its own dedicated drain and vent.

Each steamer's vent must be extended individually. Tying multiple vents together will result in the steamers being unable to regulate heat.

For the both steamers, follow the instructions as provided above in **Extension Sloping Upward.**

The lower steamer's vent must exit above the top of the upper steamer (FIGURE 14).

When designing the extension to slope downwards, whether using rigid or flexible hosing, pipe hangers or pipe supports should be used every six feet to prevent long runs from sagging. The end of the hose/pipe should not be submerged to prevent steam backups (FIGURE 15).

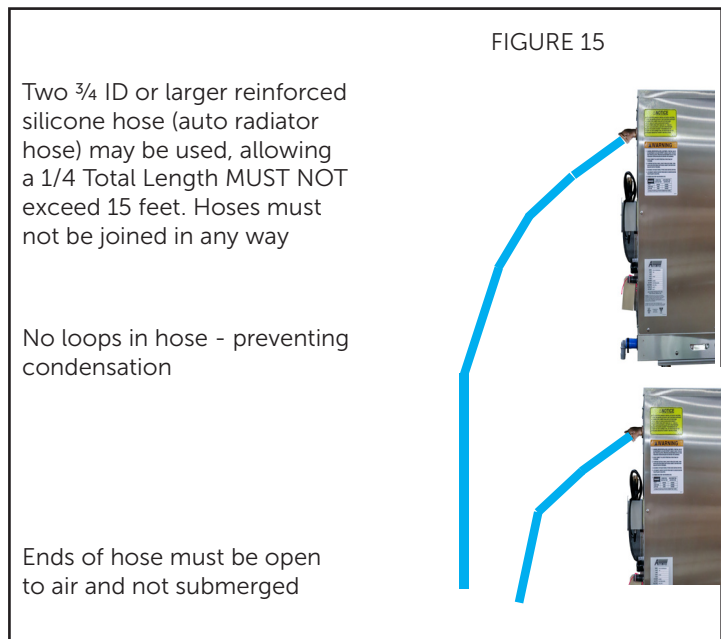
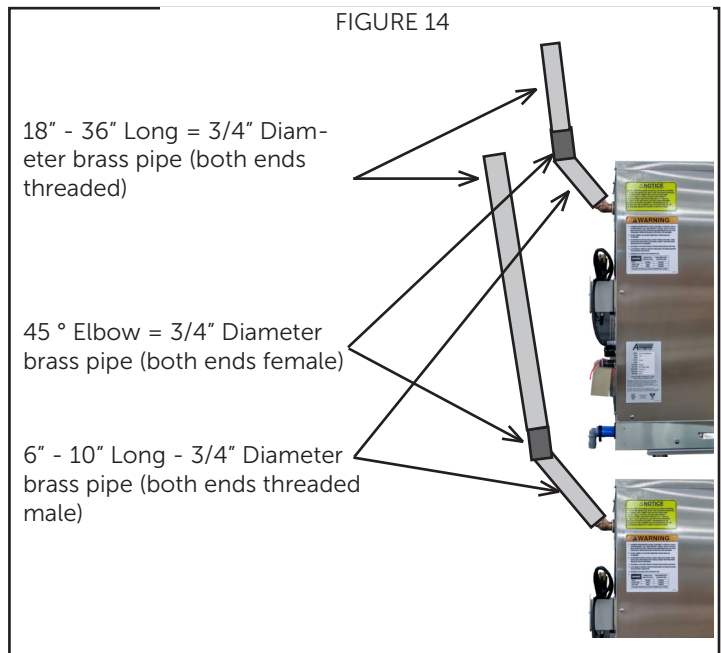
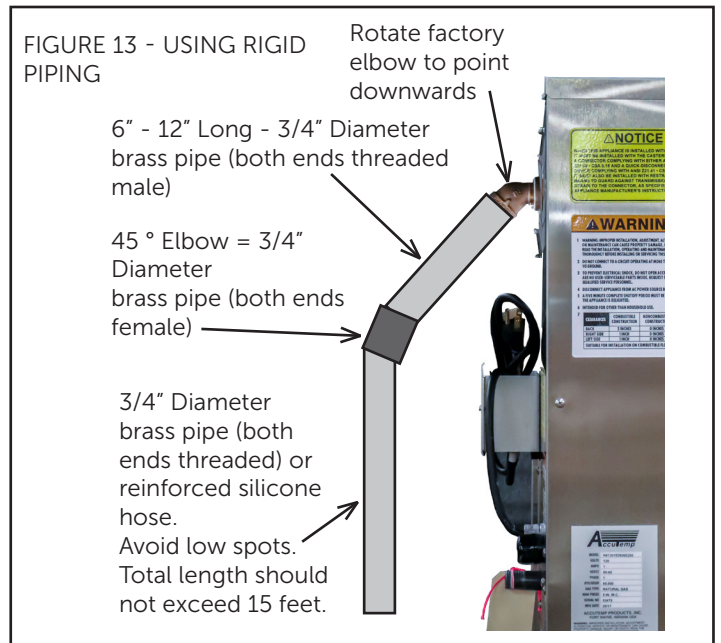



## 4. OPERATION

 RISKS RESULTING FROM CONTACT WITH VERY HOT OBJECT:

 STEAM

When opening the door, particularly during steamer operation, always stand in such a way that the hot steam escaping from the partially open door cannot scald you. Open the door only partially and open fully only once the steam has escaped.

 HOT

Hot areas may form during the cooking process, especially on the cookware, grills and the inner side of the door. Use protective gloves whenever handling hot objects. During the cooking process, do not handle cookware containing liquids or liquid foodstuffs located above eye level. Danger of burns.

 Be sure all operators read, understand and follow the information contained in this manual including caution warnings, operating instructions and safety instructions.

 When accessing the cooking chamber, be sure to always stand back while slowly opening the door to allow the chamber to vent off the steam. Never reach into the cooking chamber before it has completely vented off the steam.

 Never use wet or damp gloves as moisture can conduct heat quickly.

 Keep the floor in front of the equipment clean and dry. If spills occur, clean immediately to avoid potential injuries.

 Do not manually fill water above the water level mark on the left side of the cooking chamber.

 Do not use abrasive (or steel) materials, such as wire brushes, metal scouring pads to clean the cooking chamber bottom.

### 4.1 Operation Introduction

The AccuTemp Evolution gas steamer uses the time proven method of cooking with steam. Once the cooking time expires, the steamer can be set to the "Hold Mode". In this mode, the controller regulates the internal temperature. At this time, steam is no longer generated and the cooking chamber is held at the preset temperature at a relative humidity of 100%. This eliminates food from drying out by suppressing the evaporation of the products natural moisture. As a result, most food products can be held in a ready-to-serve state for several hours after cooking, with no appreciable loss in taste, appearance or consistency.

### 4.2 Sequence of Operation

- When power button is depressed digital display will power on and display "PrE."
- On connected models, low water light will illuminate and unit will begin to fill. On connectionless models, low water light will illuminate and alarm will sound until water is added to the cooking chamber up to the water fill level.
- When the unit has finished filling, low water light will extinguish and alarm will stop. Unit will then begin ignition cycle. Unit will begin to heat, do not open door as this will slow preheat process.
- Pressing the temperature button will allow users to see current temperature.
- Unit will display "Coo" on display when cooking temperature (approx 212F) has been achieved. The unit will maintain this temperature until powered off or user switches to Hold mode. Product can now be added.



FIGURE 17

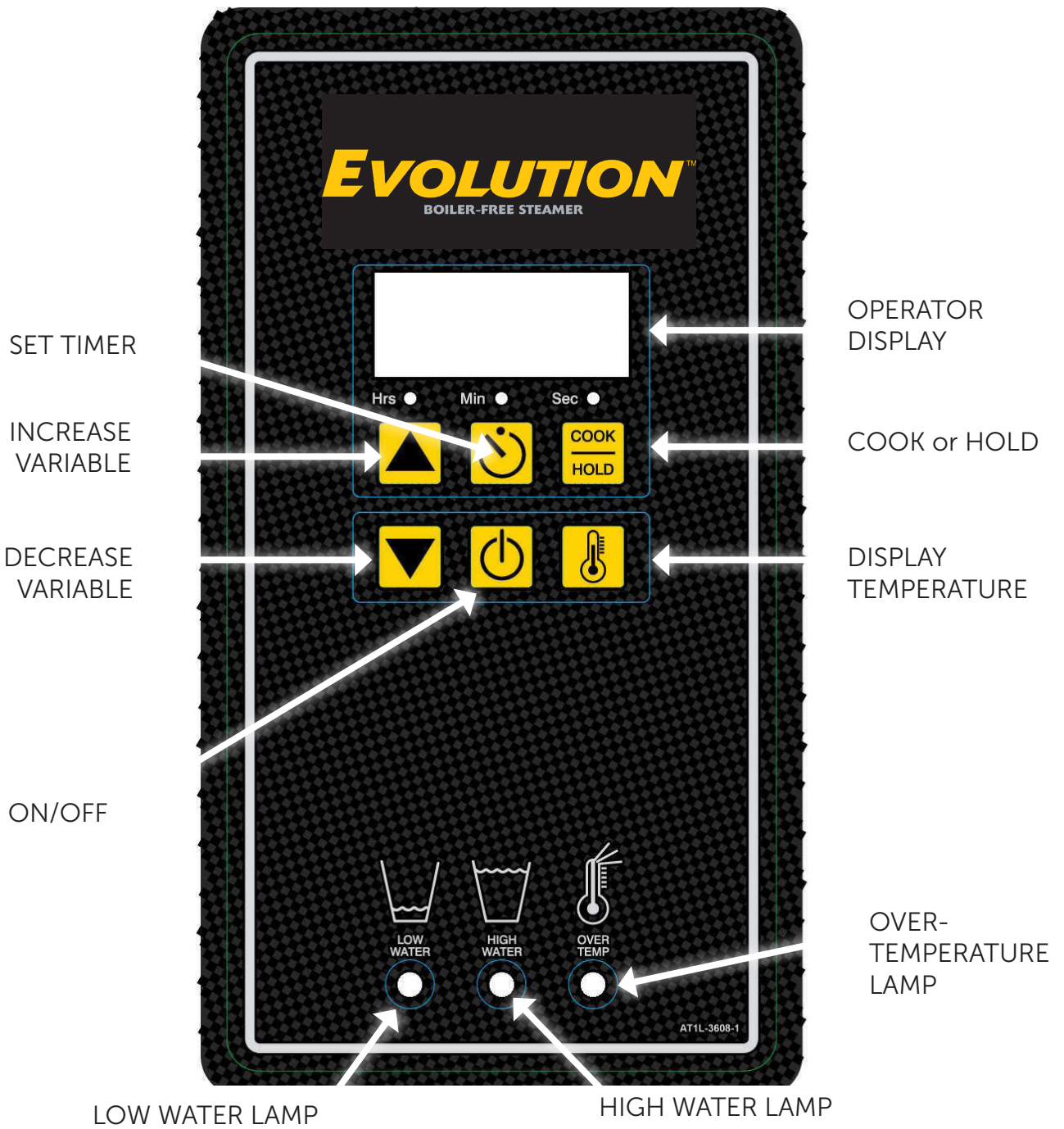

### 4.3 Partial Loads

The Evolution is designed to cook quickly with exceptional pan-to-pan uniformity on full loads of food. Excellent pan-to-pan uniformity can be achieved with partial loads if the pans are optimally placed in the steamer.

For partial loads using 2½" deep pans, the top position in the steamer is used first followed by the second pan placed in third pan position from the top and then the third pan in the fifth pan position from the top (FIGURE 18). Placing the pans in these positions will optimize the cooking time and pan-to-pan uniformity.

FIGURE 18

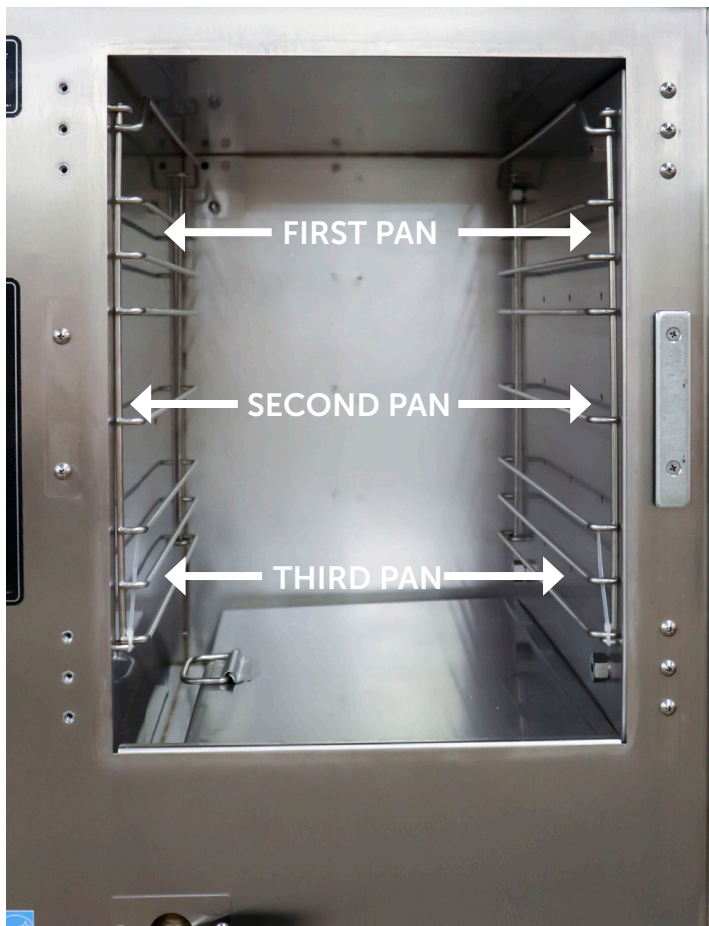

### 4.4 Daily Preparation for Use - Connected

Preparing the Evolution Connected model for use each day requires very little time and effort. Simply verify that the steamer is clean, the water line to the steamer is turned on and the drain valve is in the closed position. Close the door and push the ON/OFF key on the keypad. The steamer will automatically fill and preheat.

Since the Evolution automatically senses the water level and refills as required. There is no need to manually fill the steamer.

#### PREHEATING

1. Depress the On/Off Key to turn on the steamer. The display will indicate PrE while in Cook Mode and the temperature while in the Hold Mode.
2. Once the steamer is preheated and ready to cook, the display will indicate the COO (Cook Mode) or HLd (Hold Mode).
3. Depress the DISP TEMP button to display the current cooking temperature.

#### COOKING

1. Depress the COOK/HOLD button to select the Cook Mode (COO).
2. Open the door and place food into the cooking chamber. Shut the door. Cooking begins immediately.
3. Timer — Depress the TIMER button and depress the ARROW keys until the desired time is displayed. The timer starts automatically. At the end of the timed cycle, a beeper will sound.
4. Depress the DISP TEMP button to display the current cooking chamber temperature.

#### HOLDING

In "Hold" the steamer temperature is set for 180° F from the factory. The hold temperature can be changed to a single value for temperatures ranging from 150°F to 190°F if required. Contact the AccuTemp Technical Service Department for assistance at 800.480.0415. Hold can also be used during downtimes to save energy and water while keeping the steamer preheated.

1. Depress the COOK/HOLD button to select the Hold Mode (HLd).
2. Open the door and place food into the cooking chamber. Shut the door.
3. Food will be held at the preset holding temperature. The factory setting is set at 180° F.
4. Depress the DISP TEMP button to display the current cooking chamber temperature.

## 4.5 Daily Preparation for Use - Connectionless Model

Preparing the Evolution Connection-Less model for use each day requires very little time and effort. Simply verify that the steamer is clean, the drain valve is in the closed position and the cooking chamber is filled with approximately 2½ Gallons of tap water. Close the door and push the ON/OFF key on the keypad. The water level will need to be monitored and filled as required. Do not use the low water warning lamp as the indicator to check the water level as this can damage the steamer over time.

### PREHEATING

1. Depress the ON/OFF Key to turn on the steamer. The display will indicate PrE.
2. Once the steamer is preheated and ready to cook, the display will indicate COO (Cook Mode) or HLd (Hold Mode).
3. Depress the DISP TEMP button to display the current cooking chamber temperature. MAX temperature at sea level in 212°F

### COOKING

1. Depress the COOK/HOLD button to select the Cook Mode (COO).
2. Open the door and place food into the cooking chamber. Shut the door. Cooking begins immediately.
3. Timer — Depress the TIMER button and depress the ARROW keys until the desired time is displayed. The timer starts automatically. At the end of the timed cycle, a beeper will sound.
4. Depress the DISP TEMP button to display the current cooking chamber temperature.

### HOLDING

In "Hold" the steamer temperature is set for 180°F from the factory. The hold temperature can be changed to a single value for temperatures ranging from 150° F to 190° F if required. Contact the AccuTemp Technical Service Department for assistance at 800.480.0415. Hold can also be used during downtimes to save energy and water while keeping the steamer preheated.

1. Depress the COOK/HOLD button to select the Hold Mode (HLd).
2. Open the door and place food into the cooking chamber. Shut the door.
3. Food will be held at the preset holding temperature. The factory default setting is set at 180° F.
4. Depress the DISP TEMP button to display the current cooking chamber temperature.

## 4.6 Cleaning



Do not use a water jet or pressure washer to clean the steamer.



After cleaning procedure is complete, steamer door must be left open to allow steamer to dry. Not doing so will decrease life of door gasket.



If local water conditions cause rust inside the steamer or heavy mineral buildup, request the **AccuTemp Additional Cleaning Recommendations**.

### 4.6.1 Daily Cleaning - Connected

1. Close the drain valve and add 1 cup (8 ounces or 0.24 liters) of white vinegar to the cooking compartment. Start the steamer in the Cook Mode. The cooking compartment will automatically fill with water. After 15 minutes, turn the steamer off and allow the steamer to cool to 140°F or lower. Then open the drain valve and allow the water in the cooking chamber to drain completely.
2. Turn the steamer off and wait for the steamer to cool below 100° F
3. Open the drain valve and allow the cooking compartment to drain completely. Remove the pan racks, steam collector, overflow sensor and condensate tray for cleaning. Wipe the inside of the cooking chamber, pan rails, steam collector, overflow sensor, and condensate tray with a clean cloth (FIGURE 19). Clean the door gasket, inside of door and front face of the cooking chamber. Clean water sensors with a non metallic cleaning pad.
4. Re-install the overflow sensor, steam collector, pan rails and condensate tray. Leave the door open overnight.

(NOTE: The steamer will not operate without the overflow sensor. An alarm will also sound).

### 4.6.2 Daily Cleaning - Connectionless

1. Close the drain valve and add 1 cup (8 ounces or 0.24 liters) of white vinegar to the cooking compartment. Start the steamer in the Cook Mode. The cooking compartment will automatically fill with water. After 15 minutes, turn the steamer off and allow the steamer to cool to 140°F or lower. Then open the drain valve and allow the water in the cooking chamber to drain completely.
2. Turn the steamer off and wait for the steamer to cool.
3. Open the drain valve and allow the cooking chamber to drain completely. Remove the pan rails (FIGURE 19) and steam collector. Wipe the inside of the cooking chamber, water sensors, pan rails and steam collector with a clean cloth. Clean the door gasket, inside of door and front face of the cooking chamber.
4. Install the steam collector and pan rails. Once the water in the drain pan has sufficiently cooled empty the drain pan wipe down and replace. Leave the door open overnight.

### 4.6.3 Weekly Cleaning - Connected

1. Close the drain valve and add 1 cup (8 ounces or 0.24 liters) of white vinegar to the cooking compartment. Start the steamer in the Cook Mode. The cooking compartment will automatically fill with water. After 15 minutes, turn the steamer off and allow the steamer to cool to 140°F or lower. Then open the drain valve and allow the water in the cooking chamber to drain completely.
2. To rinse close the drain valve and start the steamer in the Cook Mode. The cooking compartment will automatically fill with water. After 15 minutes turn the steamer off and allow it to cool to 140°F or lower. Open the drain valve and let it drain completely.
3. Remove the cooking chamber components in this order: pan rails, steam distributor, steam collector, overfill sensor, power plate and dry them with a clean dry cloth.
4. Clean the water sensors with a non-metallic cleaning pad to remove any scale of debris left over after the cleaning process. Wipe with a clean dry cloth.
5. Wipe the inside of the cooking chamber with a clean dry cloth make sure to dry around the corners and seams of the cooking chamber (FIGURE 19).
6. Install the overfill sensor and the steam collector, resting the steam distributor on top of the steam collector align the 4 retaining fasteners and hand tighten, then install the pan rails and the condensate tray. Leave the door open overnight.

(NOTE: The steamer will not operate without the overfill sensor.)

### 4.6.4 Weekly Cleaning - Connection-less

1. Close the drain valve and add 1 cup (8 ounces or 0.24 liters) of white vinegar to the cooking chamber and fill with approximately 2½ Gallons of tap water, shut the door and turn the steamer on.
2. After 15 minutes, turn the steamer off and allow the steamer to cool. Open the drain valve and allow the cooking chamber to drain completely.
3. To rinse close the drain valve, fill with approximately 2½ Gallons tap water, close the door and start the steamer Cook Mode. Let it run for 15 minutes, turn the steamer off and allow the steamer to cool. Open the drain valve and allow the cooking chamber to drain completely.
4. Remove the pan racks, steam collector and steam distributor for cleaning. Clean the water sensors with a non-metallic cleaning pad. Wipe the inside of the cooking chamber, water sensors, pan rails, steam distributor and steam collector (FIGURE 19).
5. Install the steam collector first, resting the steam distributor on top of the collector align the (4) retaining fasteners and hand tighten and then install the pan rails. Leave door open overnight.

FIGURE 19

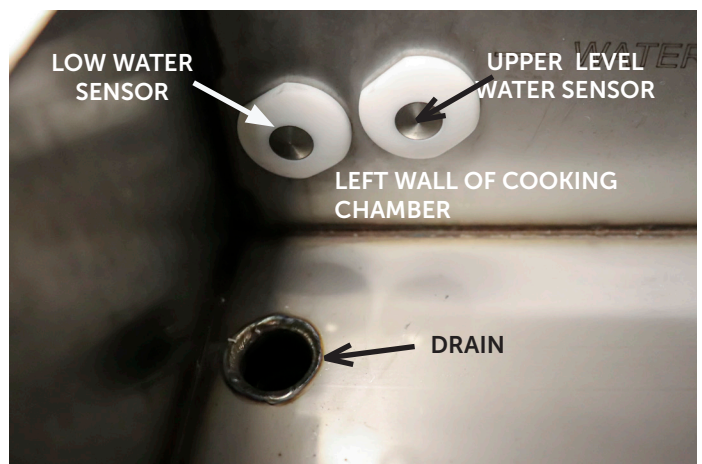

#### 4.6.5 How to to Protect Stainless Steel

AccuTemp Steamers are made from high quality stainless steel. To protect the equipment, we would recommend the following steps:

1. Use the proper tools. Never use sandpaper on stainless steel, as it can cause scratches in the steel, allowing corrosion to form. Use non-abrasive tools, like soft cloths and plastic scouring pad, stainless steel pads (scrub in direction of polishing marks).
2. Clean with the polish lines or "grain" Scrub in a motion parallel to the lines when visible lines are present. Use a soft cloth or plastic scouring pad when grain cannot be seen.
3. Use alkaline, alkaline chlorinated or non-chloride containing cleaners. Ask your supplier for an alternative if your present cleaner contains chlorides. Avoid cleaners containing quaternary salts to avoid pitting and rusting.
4. Keep your food equipment clean. Following the cleaning instructions in Section 4.6 will greatly reduce the chances of corrosion and rust.
5. Rinse and wipe equipment and supplies if chlorinated cleaners are used, dry immediately. Wipe off standing water as soon as possible, especially when it contains cleaning agents.
6. Never use hydrochloric acid (muriatic acid) on stainless steel.
7. Regularly re-passivate with oxalic acid (Bar Keepers Friend or equivalent) or citric acid (Citri-surf / Citri-clean or equivalent) . Note – these materials are stronger and more effective than vinegar. These water based acids remove traces of steel and activate the chromium oxide passive layer.
8. Always rinse the unit with clean water and dry with the steamer door and drain valve open.

## 5. Troubleshooting

### 5.1 Steamer Will Not Power On

- Verify that the steamer is plugged into the proper outlet.
- Verify the the external breaker is on.
- If the 'High Water' warning light is on open the drain valve to drain the water until the light goes out.
- Verify that the float ball is in place.

### 5.2 Steamer Will Not Fill with Water

- Ensure water supply to unit is turned on.
- Clean two water sensors in cooking cabinet

### 5.3 Steamer is Overfilling with Water (Connected)

- Ensure unit is level.
- Clean two water sensors in cooking cabinet.

### 5.4 Steamer Does Not Heat

- If the operators display doesn't light up, see Section 5.1.
- Verify the steamer door is closed, as the unit will not heat when the door is open.
- Open and the shut the door to restart the ignition system.

### 5.5 Steam Comes Out of Door (Overpressure)

- Verify that the door is completely closed and latched.
- Wait a minute to see if it stops. After the steamer refills with water it is normal for some steam to come out the door for a brief amount of time, usually less that one minute.

### 5.6 Steamer Temperature is Low

- When the steamer automatically refills the fresh water, the temperature of the steamer will drop. The steamer should reheat quickly.
- If -99F or -1F appears call AccuTemp for assistance.
- If frozen product is added the temperature will take time to recover.
- Opening and closing the door frequently can lower the temeperature and increase cook times.

If these don't solve your problem contact our Technical Service Department.

- Phone - 800.480.0415 or 260.469.3040
- Email - [service@accutemp.net](mailto:service@accutemp.net)
- Web site - [www.accutemp.net](http://www.accutemp.net)

# SERVICE

## INFORMATION

**Conventional Steamers require scheduled maintenance (such as boiler maintenance) at frequent intervals) The Evolution design doesn't require this type of scheduled maintenance. It is recommended that you schedule a yearly review of the Evolution with a AccuTemp Authorized Service Representative to keep your steamer in optimal operation**

## INFORMATION

### GENERAL SERVICE INFORMATION

**All service request during the warranty period of this appliance must be directed to the AccuTemp Products, Inc. Technical Service Department or the service call may not be covered by the limited warranty.**

## WARNING

**Only an AccuTemp Products Inc. Authorized Service Personnel or Representative must perform service. Service performed by unauthorized personnel will void all warranties.**

## INFORMATION

### IMPORTANT SERVICE INFORMATION

**AccuTemp Product, Inc. Technical & Customer Support Technician is available Monday thru Sunday, 7:00am to 7:00pm EST.**

**800.480.0415 or 260.469.3040**

**Email: [service@accutemp.net](mailto:service@accutemp.net)**



## PREVENTATIVE MAINTENANCE

Note: Accutemp approved service providers should complete any tasks involving access to gas and electrical systems.

PM TASK DESCRIPTION	DAILY	ANNUAL
Verify that the Steamer is level.	X	
Verify the operation of the control panel. When a button is pressed the display should register the input and a beep should sound.	X	
Verify the operation of the indicator lamps.	X	
Clean water fill sensors with non abrasive metallic pad. DO NOT use sandpaper.	X	
(AUTO-FILL ONLY) Ensure unit fills with water to the water level line.	X	
Lubricate hinges and door latch with a food grade silicon spray	Monthly	
Lubricate stand casters	Monthly	
Inspect AC power cord for degradation or bare wires. Replace if defective or suspect		X
Inspect door gasket for cuts and degradation. Replace if damaged. We suggest replacing once a year.		X
Inspect Steam distribution panel gasket for cuts and degradation. Replace if damaged. We suggest replacing once a year		X
Inspect and clean steam vent, condensate line fittings and hoses.		X
Inspect the flue for foreign particulate that has fallen inside. Remove any particulate. Check that the flue has not been pushed in. If the flue has been pushed in, pull the flue out so that flue opening is at the original shape.		X
Verify the operation and condition of the igniter probe/flame sense assembly. Probes should be cleaned with a stainless steel wire brush and/ or emery cloth. A stainless steel knife can also be used or a dollar bill. Caution: DO NOT use any abrasive that contains Silica. This will leave a coating on the flame sensor that could cause the unit not to light. Install Electrode Ignitor Assembly if cleaning doesn't work. We recommend replacing every two years.		X
Clean Gas Orifice		X
Inspect the control compartment for foreign particulate and any loose wiring or connections.		X
Verify that the dynamic operating pressure of the unit is at NG: 3.5"WC/ LP: 10"WC		X
Check Pressure Switch for correct operation. Recommend to replace every two years.		X
Inspect external and internal water connections and condensate lines for degradation and leaks. Replace as necessary		X

# **LIMITED WARRANTY**

## **One Year– Parts and Labor**

### **U.S. & Canada Only**

AccuTemp Products, Inc. (AccuTemp) warrants that your AccuTemp equipment will be free of defects in material and workmanship under normal use for a period of twelve (12) months from installation or fifteen (15) months from date of shipment from AccuTemp, whichever date first occurs (the Warranty Period). Registration of AccuTemp equipment is required at the time of installation. Damage to AccuTemp equipment that occurs during shipment must be reported to the carrier, and is not covered under this warranty. The reporting of any damage during shipment is the sole responsibility of the commercial purchaser/user of such AccuTemp equipment.

AccuTemp provides an active service department, which should be contacted and advised of service issues, regardless of the warranty period. During the warranty period, AccuTemp must be contacted for warranty repairs and agrees to repair or replace, at its option, F.O.B. factory, any part which proves to be defective due to defects in material or workmanship, provided the equipment has not been altered in any way and has been properly installed, maintained, and operated in accordance with the instructions in the AccuTemp Owners Manual. During the warranty period, AccuTemp also agrees to pay for any factory authorized equipment service agency (within the continental United States and Canada) for reasonable labor required to repair or replace, at our option, F.O.B. factory, any part which proves to be defective due to defects in materials or workmanship, provided the service agency has received advance approval from AccuTemp factory service to perform the repair or replacement. This warranty includes travel time not to exceed two hours and mileage not to exceed 50 miles (100 miles round trip), but does not include post start-up assistance or training, tightening of loose fittings or external electrical connections, minor adjustments, maintenance, or cleaning. AccuTemp will not reimburse the expense of labor required to replace parts after the expiration of the warranty period.

Proper installation is the responsibility of the dealer, owner-user, or installing contractor and is not covered by this warranty. Improper installation can affect your warranty. Installation is the responsibility of the Dealer, Owner/User or the Installation Contractor. See the Installation section of the Owners Manual. While AccuTemp products are built to comply with applicable standards for manufacturers, including Underwriters Laboratories (UL) and National Sanitation Foundation (NSF), it is the responsibility of the owner and the installer to comply with any applicable local codes that may exist.

AccuTemp makes no other warranties or guarantees, whether expressed or implied, including any warranties of performance, merchantability, or fitness for any particular purpose. AccuTemp liability on any claim of any kind, including negligence, with respect to the goods and services covered hereunder, shall in no case exceed the price of the goods and services, or parts thereof, which gives rise to the claim. In no event shall AccuTemp be liable for special, incidental, or consequential damages, or damages in the nature of penalties.

This constitutes the entire warranty, which supersedes and excludes all other warranties, whether written, oral, or implied.





AccuTemp product may be covered by  
one or more US Patents.  
See [www.accutempip.net](http://www.accutempip.net)

**LIFETIME**<sup>TM</sup>  
**SERVICE & SUPPORT**  
1-800-480-0415 | [service@accutemp.net](mailto:service@accutemp.net)

## INFORMATION

### IMPORTANT SERVICE INFORMATION

AccuTemp Product, Inc. Technical & Customer Support Technician is  
available Monday thru Sunday, 7:00am to 7:00pm EST.

**800.480.0415 or 260.469.3040**

- Phone - 800.480.0415 or 260.469.3040
- Email - [service@accutemp.net](mailto:service@accutemp.net)
- Web site - [www.accutemp.net](http://www.accutemp.net)