

Serial Number:	
Model:	

**XLR8™**  
UPPER HEATED PLATEN

# XLR8 UPPER HEATED PLATEN INSTALLATION & OPERATOR MANUAL



AccuTemp Products INC  
11919 John Adams Dr, New Haven IN 46774  
[www.accutemp.net](http://www.accutemp.net)

# TABLE OF CONTENTS

DESCRIPTION	PAGE
Table of Contents / Document History	1
Safety Warnings	2
General Info	3
Installation	4
Installation - Factory Prepped Griddle	7
Installation - Field Prepped Griddle	10
Operation	19
Planned Maintenance	23
Wiring Schematic	24
Limited Warranty Statement	25
Service Information	Rear Cover





# DOCUMENT HISTORY

Current Revision	Date	Prior Revision	Date	Revision
2408	08/14/2024	2011	11/15/2020	Updated: Photographs, Install instructions, Program instructions.

# 1. WARNING SYMBOL DEFINITIONS

## SYMBOL DEFINITIONS

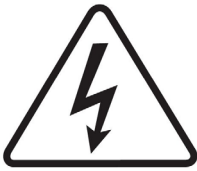
Symbols are used to attract your attention to possible dangers. They are only effective if the operator uses proper accident prevention measures. Some of the symbols are boxed text; while others maybe just picture icons. Please give this information the respect they deserve for safe operation.

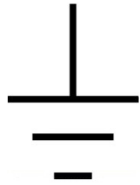
	<b>DANGER</b> Indicates an imminently hazardous situation; which, if unchanged, will result in death or serious injury.		<b>CAUTION - HOT SURFACE</b>
	<b>CAUTION</b> Indicates a potentially hazardous situation; which, if unchanged, will result in minor or moderate injury.		<b>DANGEROUS VOLTAGE</b>
	<b>NOTE</b> Advises the reader of information or instructions, vital to the operation or maintenance of the equipment.		<b>EARTH GROUND</b>

### **WARNING**

In the event of a power failure, do not attempt to operate this equipment.

### **WARNING**

Improper installation, adjustment, alteration, service or maintenance can cause property damage, injury or death. Read the installation, operating, and maintenance instructions thoroughly before installing or servicing this equipment.

### **WARNING**

Only qualified service technicians/electricians should install this equipment to ensure that all electrical and safety requirements are met and that all wiring is installed in accordance with all national, state and local electrical codes.

## 2. General Information

### 2.1 Unit Specifications

XLR8 Upper Heated Platen	
Model #	XLR82401B-00
Phase	1
Volts	208 V   240 V
Amps	10 A   11.2 A
Watts	2.1 kW   2.7 kW
Breaker Size	15A
NEMA Plus (208/240)	L6-30P
Unit Width (one arm)	11 9/16"

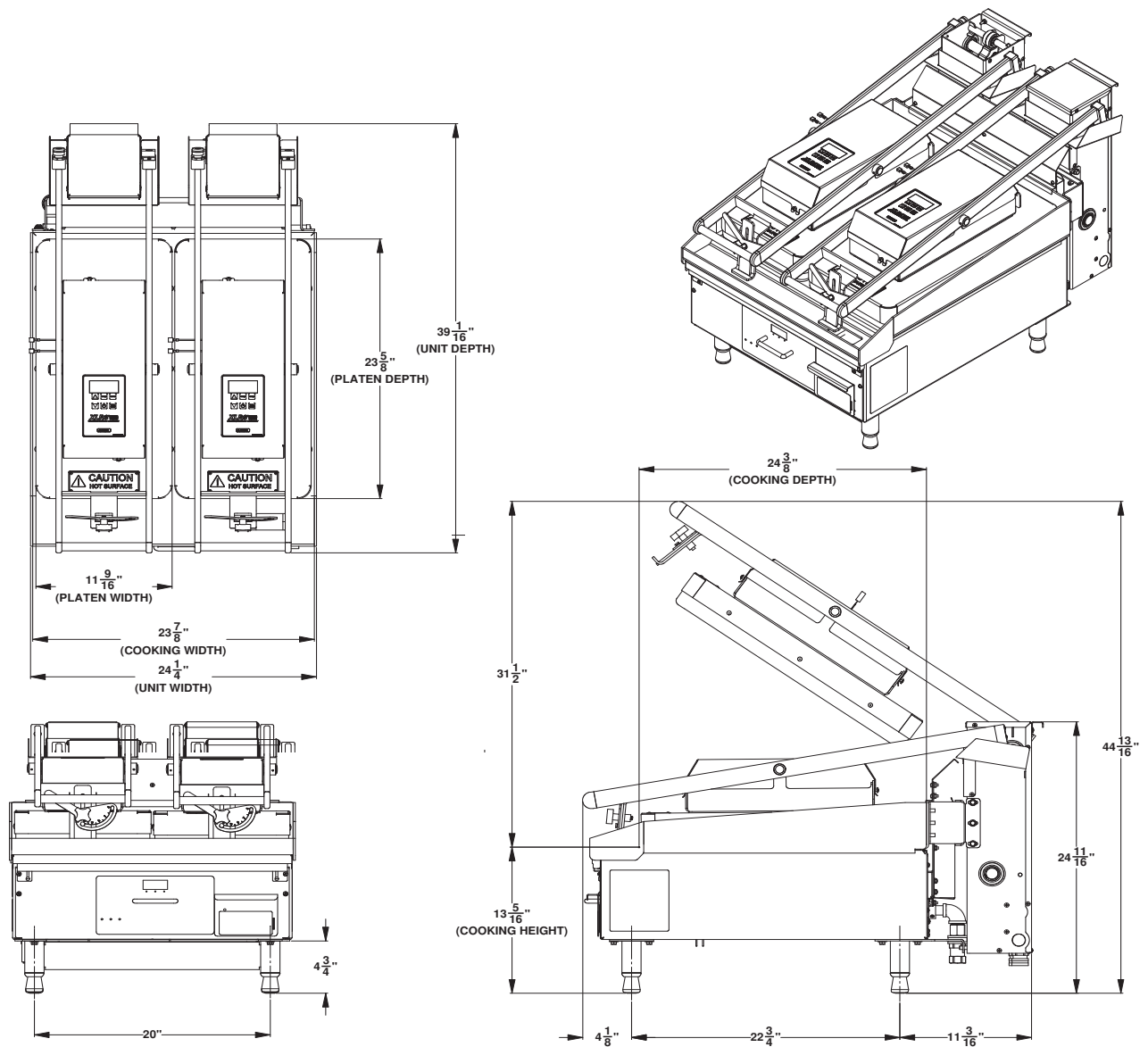

Drawing shown with (2) XLR8 Upper Heated Arms and Required Leg Stabilization Kit.

### 3. INSTALLATION

#### 3.1 INSTALLATION NOTICE

 Only qualified service technicians/electricians should perform the installation to ensure that all electrical and safety requirements are met and that all wiring installations are performed in accordance with all national, state and local codes.

#### TOOLS REQUIRED:

Standard socket set up to 3/4"	Level
Standard Wrench set up to 3/4"	Digital Clamp Ammeter
Standard Hex (allen) Wrench set up to 1/2"	Multimeter
1/2" Drive Ratchet	Weighted Temperature Probe
#2 Phillips and #2 standard screwdrivers	Digital Temperature Meter
90 degree angled #2 Phillips Screwdriver	
Torque wrench with inch/lbs or feet/lbs measurement.	

#### 3.2 UNPACKING

This equipment was carefully inspected before shipment from the factory. The transportation company assumes full responsibility for safe delivery to the customer until customer acceptance of the package. Careful inspection of the packaging and the equipment should be completed before acceptance from the transportation company.

#### 3.3 XLR8 LIFTING

The equipment is heavy enough to require additional manpower or powered assistance when installing or moving.

 When moving the equipment manually make sure there are enough people for the task as the equipment is heavy.

 Make sure the equipment is not dropped during moving. People doing the carrying could be seriously injured and/or the equipment damaged. The manufacturer does not accept any responsibility for damage resulted from such actions.

#### 3.4 LOCATION AND PLACEMENT

The XLR8 electric equipment has been designed to be mounted on an AccuTemp Accusteam griddle.

The operating temperature ranges from 150° - 440°F (93° - 204°C). Since these temperatures can also be found on surfaces around the perimeter of this commercial equipment, care should be given not to install next to or against, objects or surfaces with a low melting or flash point.



### 3.5 CLEARANCES

Location	Combustible Construction	Non-Combustible Construction
Back	2 Inches	0 inches
Right Side	1 Inch	0 inches
Left Side	1 inch	0 inches
Above Arms	26 inches (+height of griddle)	26 inches (+height of griddle)
SUITABLE FOR ALL INSTALLATION ON COMBUSTIBLE FLOORS.		

### 3.6 LEVELING

The XLR8 must be installed level to the griddle surface. An out-of-level condition Can result in uneven cooking.

### 3.7 ELECTRICAL CONNECTIONS

  This commercial equipment must be properly grounded in accordance of all current National, state and local codes. Never remove the ground prong of the plug.

#### 3.7.1 ELECTRICAL SUPPLY

 The electrical voltage requirement is listed on the data plate that is located on the lower left side panel.

 Make sure the voltage is within 10% of the voltage listed on the steamer data plate.

 Connection to any other voltage not identified on the data plate will cause damage to the components and is not covered under warranty.

 Grounding provides a path for electric current to reduce risk of shock.

 If provided with one, the plug must be plugged into a receptacle that is properly installed and grounded in accordance with all National, State and local electrical codes or in the absence of local electrical codes with the National Electric Code, ANSI/NFPA 70, or the Canadian Code, CSA C22.2 as applicable.

 Under no circumstances shall the plugs grounding prong be cut or bent to fit a receptacle other than the one specified.

 Do not use any adapters.

 Any in-field modification made that bypass the safety features of this equipment will result in serious injury or death.

 Any in-field modifications made without written authorization from AccuTemp Products, Inc. will void all written and oral warranties.

The XLR8 has been designed, manufactured and tested to meet or exceed the demanding standards of safety set forth by ANSI/NFPA 70. To ensure that this high level of safety is maintained in your installation, it is important that you read and understand the following information before attempting to use the equipment.

### 3.7.2 ELECTRICAL REQUIREMENTS

Electrical requirements are listed on the data plate located on the side of the tower. The supplied cord and the appropriate UL listed plug must be connected to the correct voltage specified on the units data tag. Make sure that the voltage at your supply receptacle is within  $\pm 10\%$  of the voltage listed on the griddle data tag. Connection to any other voltage may cause damage to components in the commercial equipment. The equipment plug must be used with the appropriate receptacle.

### 3.7.3 GROUNDING INSTRUCTIONS

Grounding provides a path for electric current to reduce the risk of shock. This product is equipped with a power cord having a grounding conductor and a grounding plug. The plug must be plugged into a grounded receptacle that is installed and grounded in accordance with local codes, or in the absence of local codes, with the *National Electric Code, NFPA 70, or the Canadian Electrical Code, CSA22.2*, as applicable

# ATTENTION

The following instructions apply for griddles that have been factory prepped to accommodate the XLR8 upper heated platen. The front stabilization bracket and the rear mounting brackets have been installed at the factory.

## 3.8 INSTALL PROCESS - MOUNTING BRACKETS - FACTORY PREPPED GRIDDLE

### 3.8.1 MOUNTING BRACKET PARTS

Ensure all hardware is present before beginning installation.

 A countertop griddle prepped for XLR8 from the factory will have the tower assembly base and rear bracket (Figure 1 & 2), front spacers and leg stabilization (Figure 3 & 4) kits pre-installed.

 A griddle due to be or already installed on a stand will require removing the legs to install the FRONT SPACERS and TOWER ASSEMBLY BASE BRACKET (Figure 1 & 2).



Figure 1



Figure 2



Figure 3



Figure 4



### 3.8.2 STAND REAR BRACE INSTALLATION INSTRUCTIONS

1. Secure the wheel (if not attached) to the brace using 1 x screw and 1 x nut. One wheel to each brace. **Do not overtighten! Wheel must be able to turn freely.**
2. Attach the braces to the rear legs of the stand, threads inboard. Tighten to 240inlbs/20ftlbs.

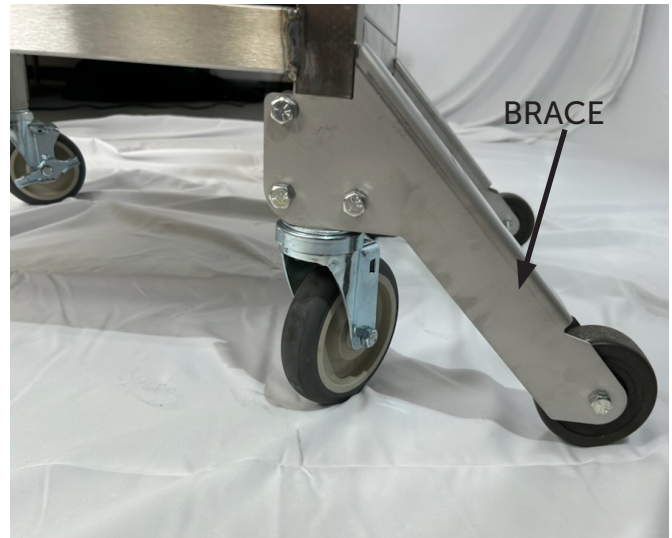

Figure 5



Figure 6

### 3.8.3 STAND MOUNTING INSTRUCTIONS

1. Install griddle on stand per instructions in the griddle installation & operator manual. Loosely secure hardware. Remove necessary hardware to install one bracket at a time per the following steps.
  - A. Insert the front spacers between the mounting holes on the griddle and the stand (Figure 7) and secure hardware.

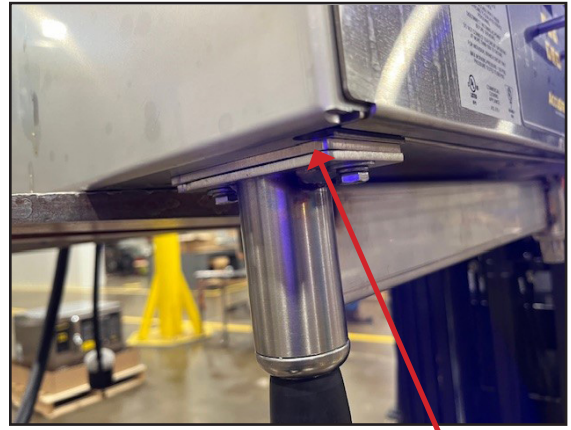

Figure 7 Front Spacer

- B. Line up the tower base bracket with the rear griddle mounting holes (Figure 8) and secure using 1" x 1/4" hardware. Tighten to 75inlbs or 6.25 ftlbs



Figure 8

2. Install the tower assembly rear bracket to the six studs on the rear backsplash of the griddle (Figure 9).

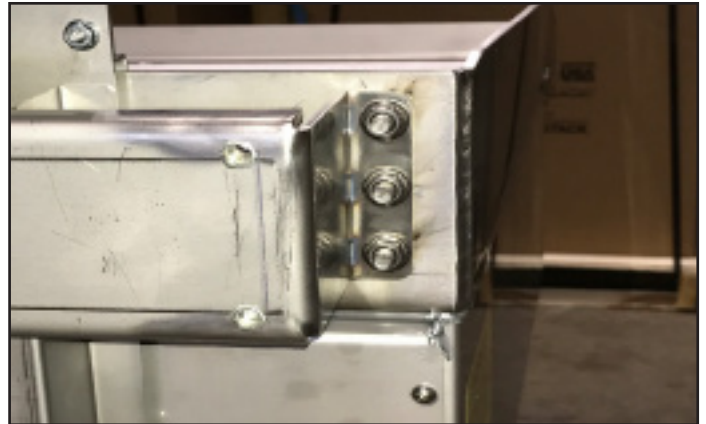

Figure 9

# ATTENTION

The following instructions pertain to griddles being modified in the field to accommodate the XLR8.

## 3.9 INSTALL PROCESS - MOUNTING BRACKETS - FIELD ASSEMBLED GRIDDLE

### 3.9.1 MOUNTING BRACKET PARTS

Ensure all hardware is present before beginning installation.

 A griddle already installed on LEGS will require separating from the legs to install the FRONT STABILIZER and TOWER ASSEMBLY BASE BRACKET.

 A griddle due to be or already installed on a STAND will require separating from the stand to install the FRONT SPACERS and TOWER ASSEMBLY BASE BRACKET.

 Prior to installing the XLR8 accessory, the griddle backsplash will need preparing.

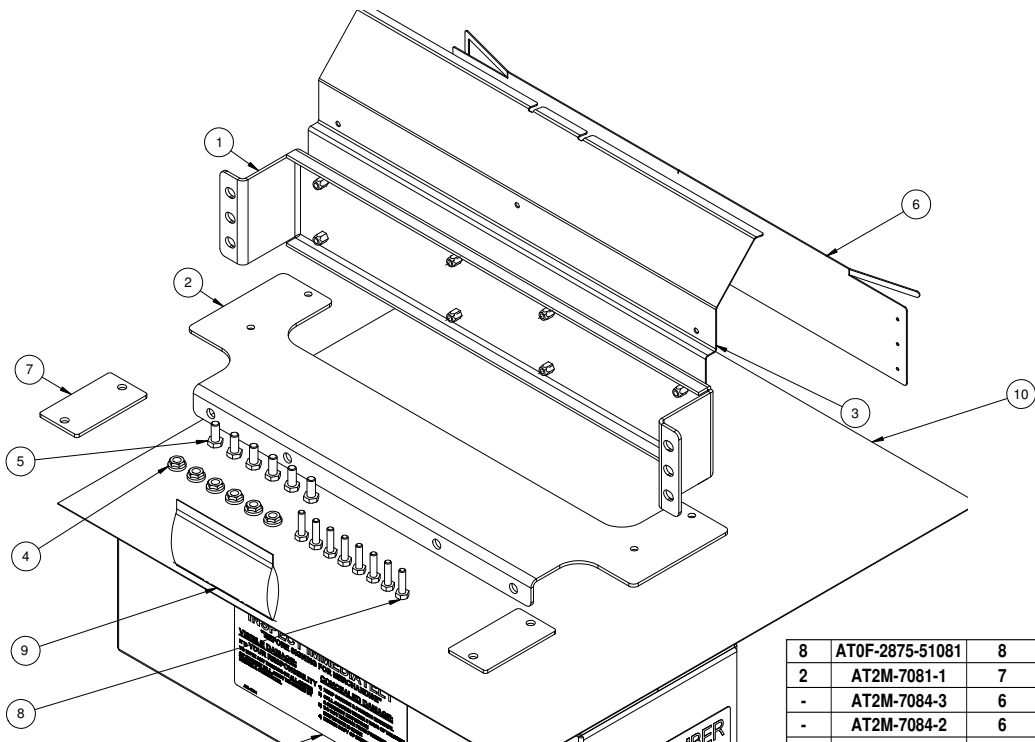

8	AT0F-2875-51081	8	SCREW, 1/4-20UNC X 1 HEX HEAD MACHINE
2	AT2M-7081-1	7	MOUNTING PLATE, LEG
-	AT2M-7084-3	6	TEMPLATE, MARKING, XLR8
-	AT2M-7084-2	6	TEMPLATE, MARKING, XLR8
1	AT2M-7084-1	6	TEMPLATE, MARKING, XLR8
6	AT0F-2875-61060	5	SCREW, 5/16-18UNC X 3/4 HEX HEAD MACHIN
6	AT0F-1017-61001	4	NUT, 5/16-18UNC HEX SERRATED
-	AT2A-7088-3	3	BRACKET ASSY, DRAFT DIVERTER 48"
-	AT2A-7088-2	3	BRACKET ASSY, DRAFT DIVERTER 36"
1	AT2A-7088-1	3	BRACKET ASSY, DRAFT DIVERTER 24"
-	AT2M-7085-3	3	BRACKET, DRAFT DIVERTER - 48"
-	AT2M-7085-2	3	BRACKET, DRAFT DIVERTER - 36"
-	AT2M-7085-1	3	BRACKET, DRAFT DIVERTER - 24"
-	AT2M-7082-3	2	BRACKET, TOWER SUPPORT, BOTTOM
-	AT2M-7082-2	2	BRACKET, TOWER SUPPORT, BOTTOM
1	AT2M-7082-1	2	BRACKET, TOWER SUPPORT, BOTTOM
-	AT2A-7087-3	1	BRACKET ASSY, LIFT
-	AT2A-7087-2	1	BRACKET ASSY, LIFT
1	AT2A-7087-1	1	BRACKET ASSY, LIFT

### 3.9.2 GRIDDLE BACKSPLASH PREPARATION

1. Ensure template received is the correct size for the width of the griddle. The template should be placed so that it sits flush with the rear backsplash (Figure 10) of the griddle and should touch both the left and right side splashes (Figure 11). For extra security C clamps can be used to hold the template flush.
2. Use the 6 guide holes on the template to start pilot holes in the griddle backsplash (Figure 11) using a drill bit of sufficient hardness for use with 304 stainless steel.
3. Drill final holes using a 17/64th drill bit.
4. Continue drilling slowly through the griddle backsplash, using cutting fluid as needed.
5. After 6 holes have been drilled, template can be removed from the backsplash.

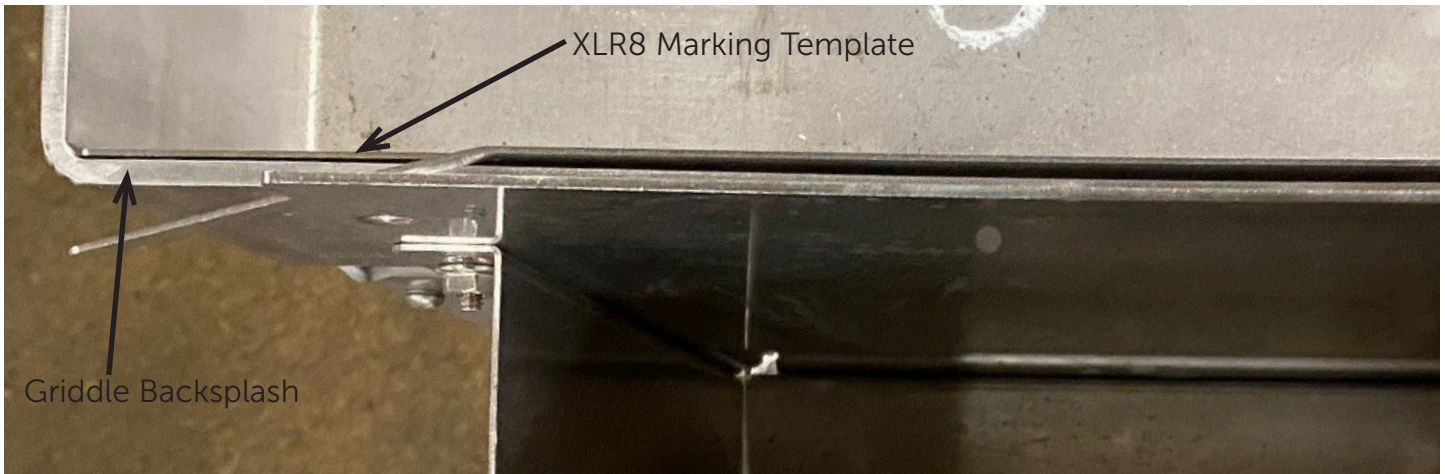

Figure 10



Figure 11

### 3.9.3 STAND REAR BRACE INSTALLATION INSTRUCTIONS

1. Secure the wheel (if not attached) to the brace using 1 x screw and 1 x nut. One wheel to each brace. **Do not overtighten! Wheel must be able to turn freely.**
2. Attach the braces to the rear legs of the stand, threads inboard. Tighten to 236inlbs/20ftlbs.

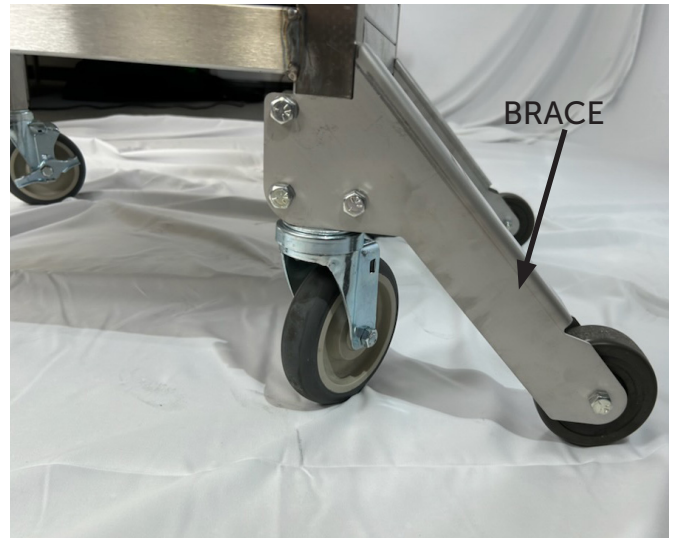

Figure 12



Figure 13

### 3.9.4 STAND MOUNTING INSTRUCTIONS

1. Install griddle on stand per instructions in the griddle installation & operator manual. Loosely secure hardware. Remove necessary hardware to install one bracket at a time per the following steps.
  - A. Insert the front spacers between the mounting holes on the griddle and the stand (Figure 14) and secure hardware.

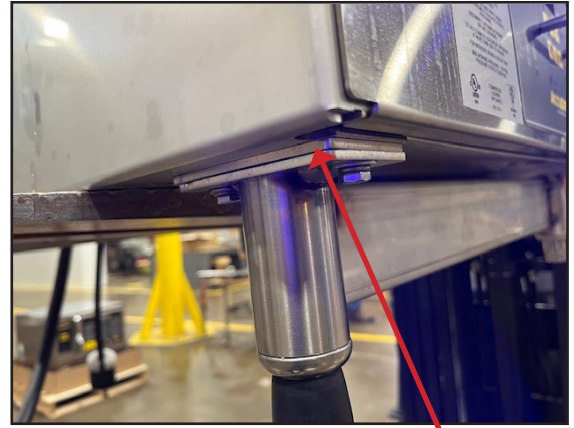

Figure 14 Front Spacer

- B. Line up the tower base bracket with the rear griddle mounting holes (Figure 15) and secure hardware. Tighten to 75inlbs or 6.25 ftlbs



Figure 15

2. Install the tower assembly rear bracket. Thread 1 x 5/16" screws through the 6 holes made in the griddle back splash into the rear support bracket. Secure each screw with 5/16" serrated flange nut (Figure 16).

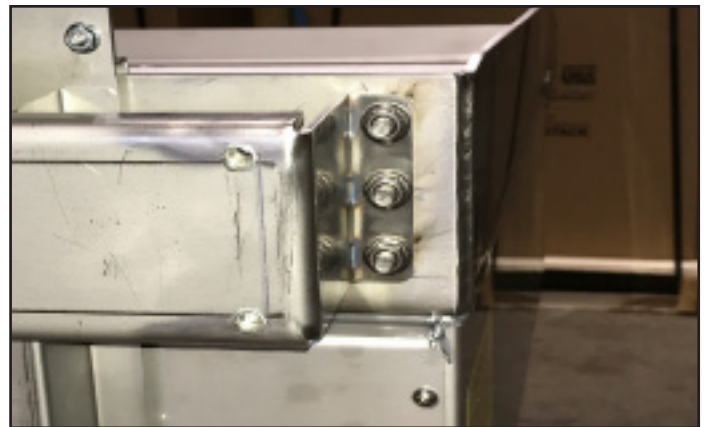

Figure 16

### 3.9.5 LEG MOUNTING INSTRUCTIONS

**ATTENTION** - The following instruction should be used if the griddle is being installed on a counter-top instead of a stand.

1. Install the tower base bracket, front spacers and front leg stabilizer. It is advised to use lift equipment at this stage to prevent injury.
  - A. Lift the griddle to allow the front and rear legs to be removed. Then insert the front spacer between the mounting holes on the griddle and front leg stabilizer assembly and secure using original hardware (Figure 17). Original single front legs can be disposed of.

Figure 17

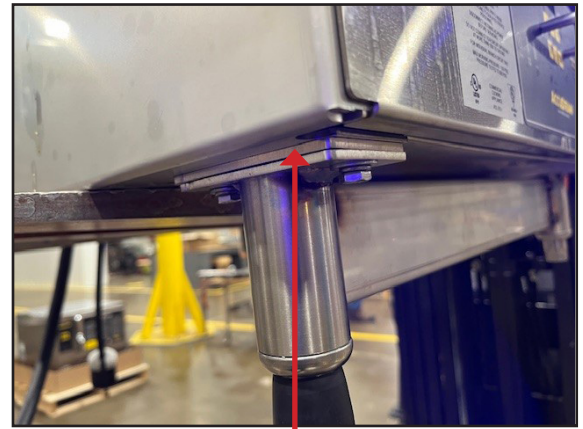

Front Spacer



- B. Insert the tower base bracket between the rear griddle mounting holes and rear legs and secure using original hardware (Figure 18).
2. Install the tower assembly rear bracket. Thread 1 x 1/4" screws through the 6 holes made in the griddle back splash into the rear support bracket. Secure each screw with 6 x 5/16" nut (Figure 19).

Figure 18



Figure 19



## 3.10 TOWER AND PLATEN MOUNTING

### 3.10.1 - Tower Installation

1. To mount the tower assembly to the griddle:
  - A. Align the studs on the tower bottom bracket with the holes on the tower base bracket. Secure but do not snug hardware to help support weight of tower assembly (Figure 20).

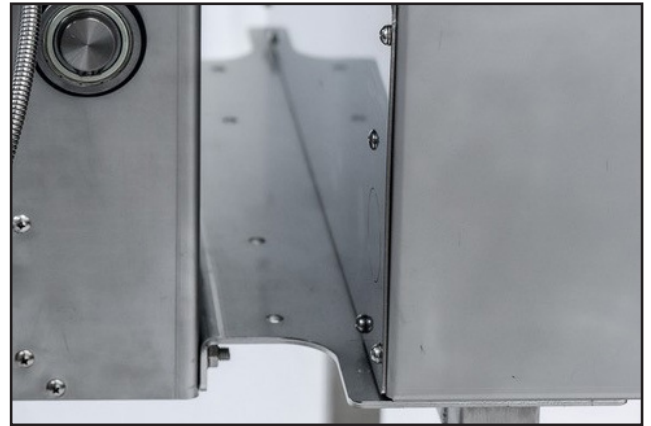

Figure 20

- B. Align mounting bracket with the tower assembly rear bracket and thread screws through mounting bracket into rear bracket (Figure 21).
    - C. Use serrated flange headed screws to secure the bracket.
    - D. Ensure both arms are square with the griddle. Use the griddle sides as a reference, then snug the nuts on the tower bottom bracket to 132 inlbs.



Figure 21



### 3.10.2 - Platen Installation

1. To mount the arm assembly to the tower assembly:
  - A. Prethread the two arm mounting bolts through the holes at the rear of the arm assembly (Figure 22).

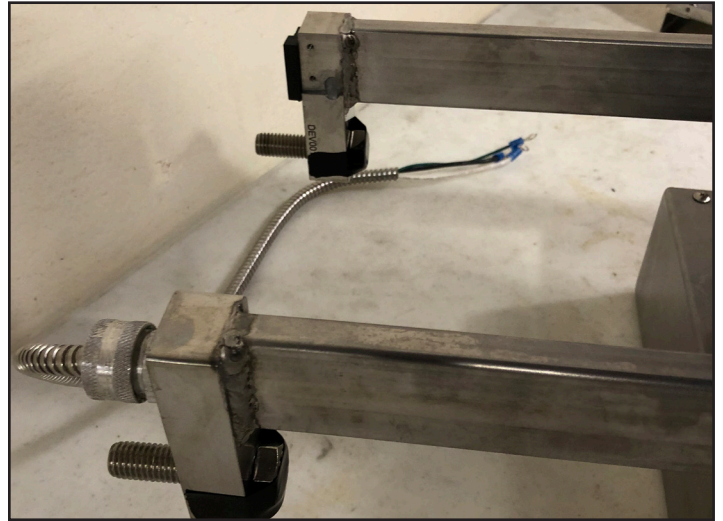

Figure 22

- B. Lift the arm (requires two people) and slide the bolts through the mounting holes in the flattened shaft extending from both sides near the top of the tower assembly.
    - C. While one person holds the arm in place at the highest position, the other should secure the bolts in place using 1/2-13 nyloc nuts, tighten to 43 ftlbs. (Figure 23).



Figure 23

### 3.10.3 - Connect power cord to tower terminal

1. Remove rear sheet metal panel from tower assembly.
2. Route arm power cord through cord grip on bottom of tower assembly. Ensure there is enough slack to connect cord ends to fuse block.
3. Secure cord to side of tower assembly using supplied spring clip and screw.
4. Connect arm power cord to upper side of terminal block (Figure 24).

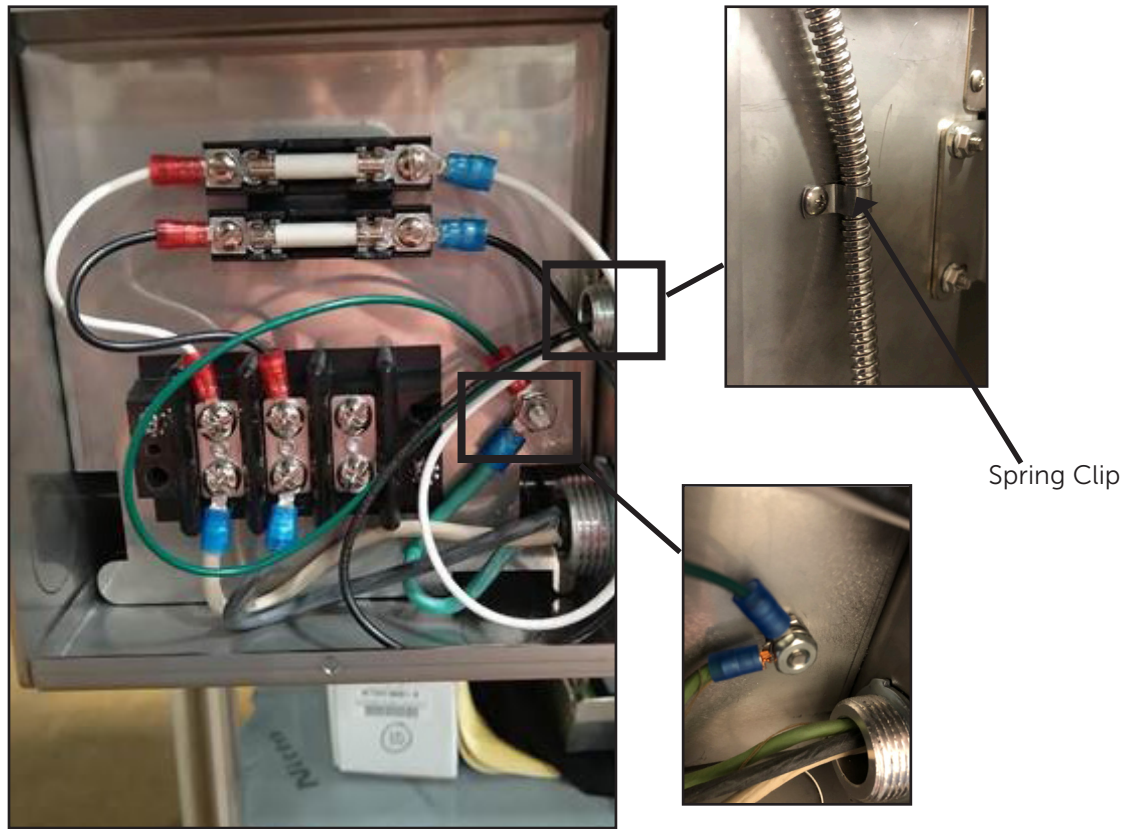

Figure 24

### 3.10.4 Install Teflon Sheets

5. Install the teflon sheet to the arm:
  - A. Raise the two teflon retention handles off the arm. These are located on the left and right hand side of the platen.
  - B. Secure one side of the teflon sheet using one handle, keeping the handle at the central point of the arm (Figure 25).Stretch the teflon across the underside of the platen and secure with the other retaining handle.



Figure 25

### 3.10.5 Install Grease Shield

1. Bring arm to raised position.
2. The grease shield is secured by four phillips head screws. Identify the mounting holes on the shield and on the tower of the XLR8, just above the mounting brackets.
3. Slot the grease shield into place under the arm, secure using screws (Figure 26 & Figure 27).



Figure 26

GREASE SHIELD



Figure 27

MOUNTING SCREW

### TEST INSTALL

1. Plug in tower power cord to correct NEMA receptacle.
2. Power the XLR8 on using control buttons located on top of the arm.
3. Keep arm elevated and allow to heat to temperature displayed on control digital display.
4. Monitor temperature using a wand type temperature meter.
5. Once unit has reached temperature allow 15 minutes for it to stabilize, then take three temperature readings from the front, middle and back of the arm cooking surface.
6. The temperatures should be within 5+/-F of the temperature displayed.

## 4. OPERATION

**!** RISKS RESULTING FROM CONTACT WITH VERY HOT OBJECT:



**HOT**

Hot areas may form during the cooking process. Use protective gloves whenever handling hot objects.

During the cooking process, do not handle cookware containing liquids or liquid foodstuffs located above eye level. Danger of burns.

**!** Be sure all operators read, understand and follow the information contained in this manual including caution warnings, operating instructions and safety instructions.

**!** Never use wet or damp gloves as moisture can conduct heat quickly.

**!** Keep the floor in front of the equipment clean and dry. If spills occur, clean immediately to avoid potential injuries.

**!** Do not use abrasive (or steel) materials, such as wire brushes, metal scouring pads to clean the teflon sheet surface.

### 4.1 VISUAL IDENTIFICATION

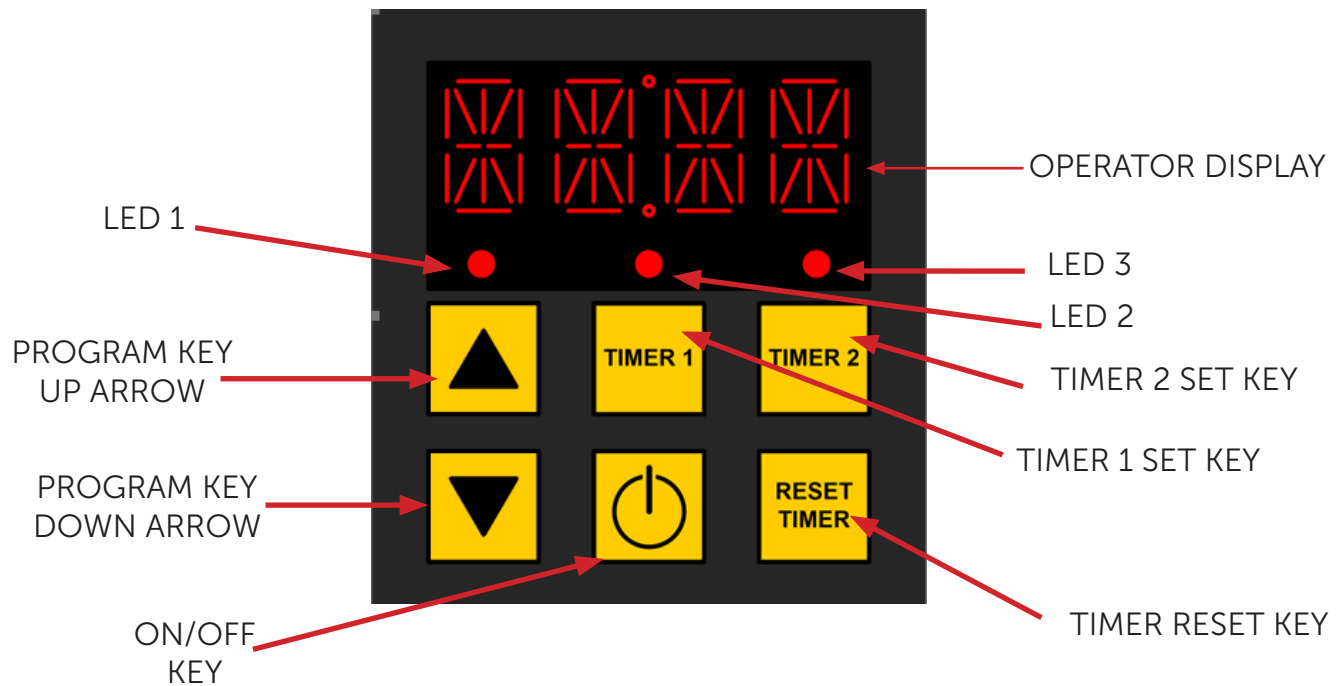

Figure 28

## 4.2 CONTROL OVERVIEW

The equipment digital temperature control is easy to operate and requires little customer interface.

### OPERATOR DISPLAY AND KEYPAD



#### 4.2.1 PREHEAT MODE

When powered on from cold the unit will constantly display "PRE-HEAT" while the appliance warms up.

During this mode timers are disabled. When the appliance is within 5 degrees Fahrenheit of the setpoint the control will transition to cook mode. A timer will not begin in this state.

In Cook mode the unit will constantly display the current set point temperature.

#### 4.2.2 SETPOINT CONTROL

The control has a single setpoint that is adjustable by the user during operation and in manager mode. When the user adjusts the setpoint value during operation it is saved to memory. The default setpoint is 400°F.

To adjust the set point:

1. Push the UP arrow to increase temperature and the DOWN arrow to decrease temperature. The display will change to show the current set point.
2. Once the desired temperature has been selected, no further interaction with keys are necessary, the unit will automatically save the selected temperature as the desired default.

#### 4.2.3 TIMER CONTROL

Once in COOK mode, the user can select either timer 1 or timer 2 option by depressing the key. Each timer has a two stage option. By default, each timer will be set to single stage operation (see 4.2.4 for information on programming two stage operation).

LED 2 will blink if Timer 1 is being adjusted, LED 3 will blink if timer 2 is being adjusted.

Use the UP and DOWN arrows to adjust the timer value for the selected timer. After two seconds with no interaction, the control will automatically accept the new value.

#### 4.2.4 - PROGRAMMING MODE

Manager mode allows for greater access to the XLR8 programming.

To enter Manager Mode press and hold DOWN arrow and TIMER RESET while the unit is powered OFF. The control is now in Program Mode and LED 1, 2 and 3 will blink, and the keypad will be re-configured as shown in the following table:

UP ARROW: Toggle between program selection and program adjustment.	TIMER 1: Save current settings and exit manager mode	TIMER 2: Increase current displayed programming parameters
DOWN ARROW: NOT USED	POWER KEY: Exit manager mode without saving.	TIMER RESET: Decrease current displayed programming parameters

The following settings can be adjusted in manager mode:

PROGRAM #	TEXT DISPLAY	MIN VALUE	MAX VALUE	DEFAULT VALUE
P01	AUTO START TIMER	NO	YES	YES
P02	TEMPERATURE SETPOINT	150F	440F	400F/204C
P03	TIMER 1 STAGE 1 VALUE	0:05	15:00	1:00
P04	TIMER 2 STAGE 2 VALUE	0:00	15:00	0:00
P05	TIMER 2 STAGE 1 VALUE	0:05	15:00	2:00
P06	TIMER 2 STAGE 2 VALUE	0:00	15:00	0:00
P07	TEMPERATURE UNIT	F	C	F
P08	RESET TO DEFAULT	NO	YES	NO

 Any other programs displayed apart from the options listed should not be changed in any way.

#### Programming Mode Example - Changing Temperature Unit setting

With the unit powered off, hold the DOWN arrow and TIMER RESET keys until P01 is displayed on the screen.

Use the TIMER 2 button to cycle through programs until P07 is displayed.

Depress the UP arrow to enter the selected program.

Use the Timer 2 button to cycle through the program choices (in the case between F and C).

Once the chosen value is displayed, depress TIMER 1 key to save and exit. The display will power off and the new setting is now saved to memory.

#### 4.2.5 - USER LOCKOUT

User lockout is a hidden parameter that disables the user from changing the Timer and Temperature setpoints from the default values. The end user will still be able to power the unit on and select either timer 1 or timer 2.

To toggle the unit between locked/unlocked press and hold the UP arrow and TIMER 2 keys. The unit will display LOCKED or UNLOCKED on the display and power down.

### 4.3.1 CLEAN AFTER INSTALLATION

It is recommended that you clean your XLR8 thoroughly before using it for the first time. To clean the equipment cooking surface, just simply wash it down with a solution of mild soap and water, then rinse thoroughly with clean water and wipe dry with a clean towel.

### 4.3.2 PREHEATING

Press the **ON/OFF** and select the desired preset. The upper platen should be approximately 40-50F hotter than the griddle surface to achieve good caramelization on product.

The equipment will be preheated when the selected set temperature is displayed and the corresponding LED goes solid. Please use caution as temperatures on and around the cooking surface could cause severe burns.

### 4.3.3 ADJUSTING THE PLATEN GAP HEIGHT

The XLR8 arm has a simple mechanism for adjusting the platen gap:

1. Turn the lock knob on the front counter-clockwise to loosen the height adjuster (Figure 28).
2. Use the handle on the adjuster to raise or lower the height of the platen. The numbers on the adjuster are arbitrary and do not correspond to a specific measurement.
3. Once the desired height is reached, turn the knob counter-clockwise to lock the platen height adjustment.

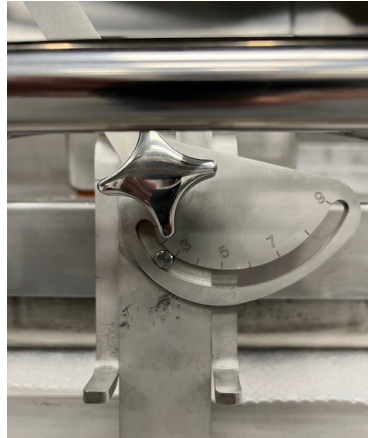

### 4.3.4 COOKING

If a recipe is provided for the product you are preparing, always follow your company guidelines for preparing product.

If adjusting your own recipe to incorporate the use of the XLR8 it is recommended to apply the following steps:

1. Divide the total cook time applied to a product cooking on just the griddle surface by half. Adjust the time from there until you are happy with the finished product.
2. Once you have the time and temperature for the product identified, use the programming instructions to set the timer and presets accordingly.
3. A smaller gap between platen and griddle surface will decrease cook time but may result in a dryer product.

### 4.3.5 CLEANING

- Hold the power button for approximately 2 seconds to power unit off and allow to cool until it is safe to touch, approximately 30 minutes.
- Remove teflon sheet and clean using mild soap and water solution and a towel.
- To clean the arm, once cooled, clean using mild soap and water solution and a towel. Rinse when done with clean water and allow to dry overnight.

 Do not Power Spray the griddle or XLR8 Upper Heated Platen. A non-Metallic cleaning pad can be used to remove large debris or built up areas.

## 5. PLANNED MAINTENANCE CHECKLIST

 It is recommended that you contact your AccuTemp authorized service provider to setup a planned maintenance program to keep your equipment operating in the most efficient manner. AccuTemp recommends a minimum of a yearly schedule.

 Only qualified service technicians/electricians should perform the biannual and yearly planned maintenance to ensure that all electrical and safety requirements are met and performed in accordance with all national, state and local codes.

PM TASK DESCRIPTION	Daily	Biannual	Yearly
Verify that the equipment is level and properly located under the hood.		X	X
Verify that the temperature controller is working properly and that there are no rips in the overlay.	X	X	X
Inspect the control compartment for foreign particulate and any loose wiring or connections.		X	X
Check that the power supply cord is not frayed, outer covering is not degraded or any bare cooper is visible. Replace if required.	X	X	X
Verify current draw to listed current requirements on the data tag of the equipment.		X	X
Verify mounting fasteners are in place and tight. If not, correct. If the stand has casters check that the wheels are intact and that they are mounted correctly. If grease covered, clean with a mild detergent and clean water. Dry completely.	X	X	X
After all metallic areas are cool to the touch, clean external metal surfaces except the cooking surface. With a damp clean towel saturated with a mild detergent and clean water. Dry with a clean dry towel.	X	X	X



## 6. Wiring Schematic

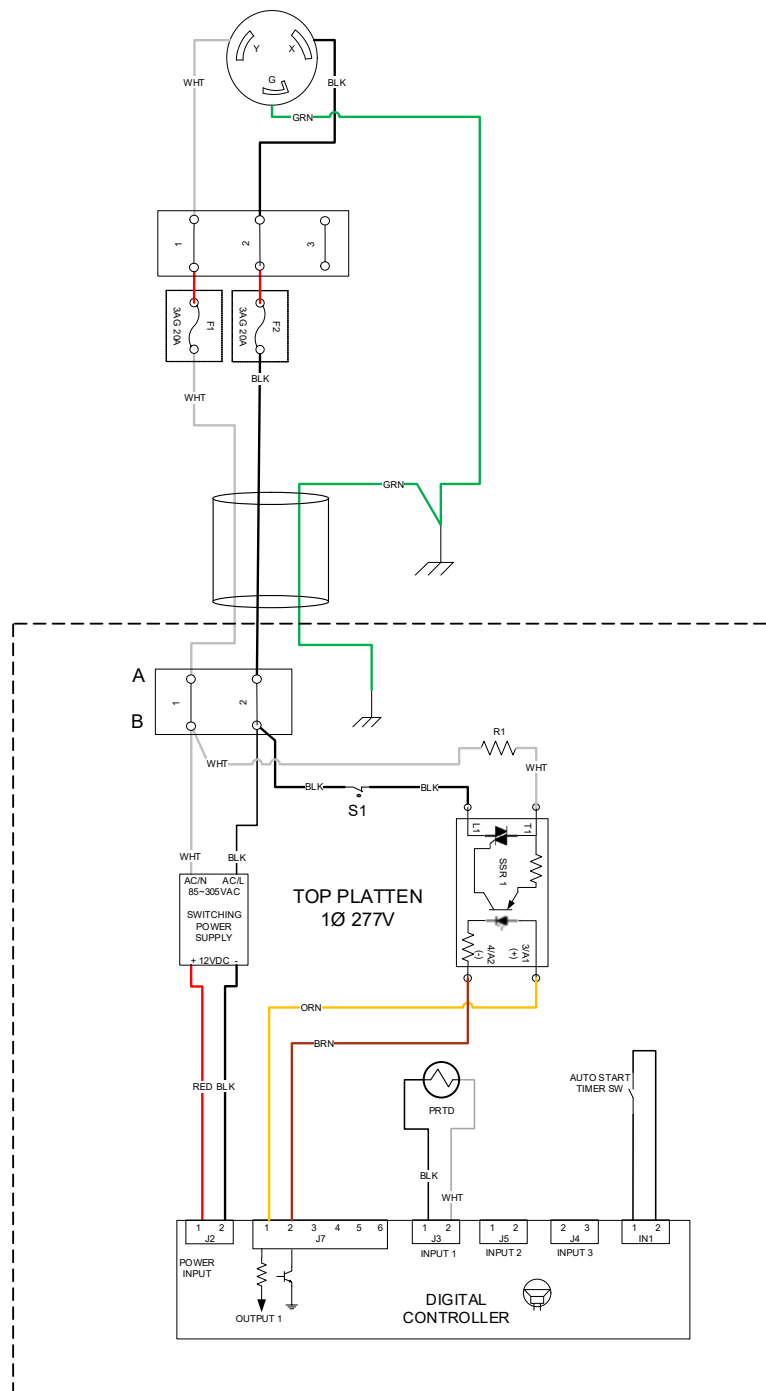

## **LIMITED WARRANTY**

### **One Year Parts and Labor**

AccuTemp Products, Inc. (AccuTemp) warrants that your AccuTemp equipment will be free of defects in material and workmanship under normal use for a period of twelve (12) months from installation or fifteen (15) months from date of shipment from AccuTemp, whichever date first occurs (the Warranty Period). Registration of AccuTemp equipment is required at the time of installation. Damage to AccuTemp equipment that occurs during shipment must be reported to the carrier, and is not covered under this warranty. The reporting of any damage during shipment is the sole responsibility of the commercial purchaser/user of such AccuTemp equipment.

AccuTemp provides an active service department, which should be contacted and advised of service issues, regardless of the warranty period. During the warranty period, AccuTemp agrees to repair or replace, at its option, F.O.B. factory, any part which proves to be defective due to defects in material or workmanship, provided the equipment has not been altered in any way and has been properly installed, maintained, and operated in accordance with the instructions in the AccuTemp Owner's Manual. During the warranty period, AccuTemp also agrees to pay for any factory authorized equipment service agency (within the continental United States and Canada) for reasonable labor required to repair or replace, at our option, F.O.B. factory, any part which proves to be defective due to defects in materials or workmanship, provided the service agency has received advance approval from AccuTemp to perform the repair or replacement. This warranty includes travel time not to exceed two hours and mileage not to exceed 50 miles (100 miles round trip), but does not include post start-up assistance or training, tightening of loose fittings or external electrical connections, minor adjustments, maintenance, gaskets or cleaning. AccuTemp will not reimburse the expense of labor required to replace parts after the expiration of the warranty period.

Proper installation is the responsibility of the dealer, owner-user, or installing contractor and is not covered by this warranty. Improper installation can affect your warranty. Installation is the responsibility of the Dealer, Owner/User or the Installation Contractor. See the Installation section of the Owner's Manual. While AccuTemp products are built to comply with applicable standards for manufacturers, including Underwriters Laboratories (UL) and Underwriters Laboratories Sanitation requirements, it is the responsibility of the owner and the installer to comply with any applicable local codes that may exist.

AccuTemp makes no other warranties or guarantees, whether expressed or implied, including any warranties of performance, merchantability, or fitness for any particular purpose. AccuTemp liability on any claim of any kind, including negligence, with respect to the goods and services covered hereunder, shall in no case exceed the price of the goods and services, or parts thereof, which gives rise to the claim. In no event shall AccuTemp be liable for special, incidental, or consequential damages, or damages in the nature of penalties.

This constitutes the entire warranty, which supersedes and excludes all other warranties, whether written, oral, or implied.







**LIFETIME™**  
**SERVICE & SUPPORT**  
1-800-480-0415 | [service@accutemp.net](mailto:service@accutemp.net)



**IMPORTANT SERVICE INFORMATION**

AccuTemp Product, Inc. Technical & Customer Support Technician is available Monday thru Sunday, 7:00am to 7:00pm EST.

**800.480.0415 or 260.469.3040**

- Tel: 800.480.0415 or 260.469.3040
- Email - [service@accutemp.net](mailto:service@accutemp.net)
- Web site - [www.accutemp.net](http://www.accutemp.net)